

***INTEGRAL SOFTWARE  
ENGINEERING METHODOLOGY  
(ISEM) FORMAL DESIGN LANGUAGE***

by Kent D. Palmer

SOFTWARE ENGINEERING  
FOUNDATIONS: Part III

Appendix 4

Entity Relationship diagrams  
for Integral Software Engineering Methodology

PO Box 4402  
Garden Grove CA 92842  
714-638-7376

Integral Software Engineering Methods (ISEM) --- Entity Relation Diagram For ISEM Language

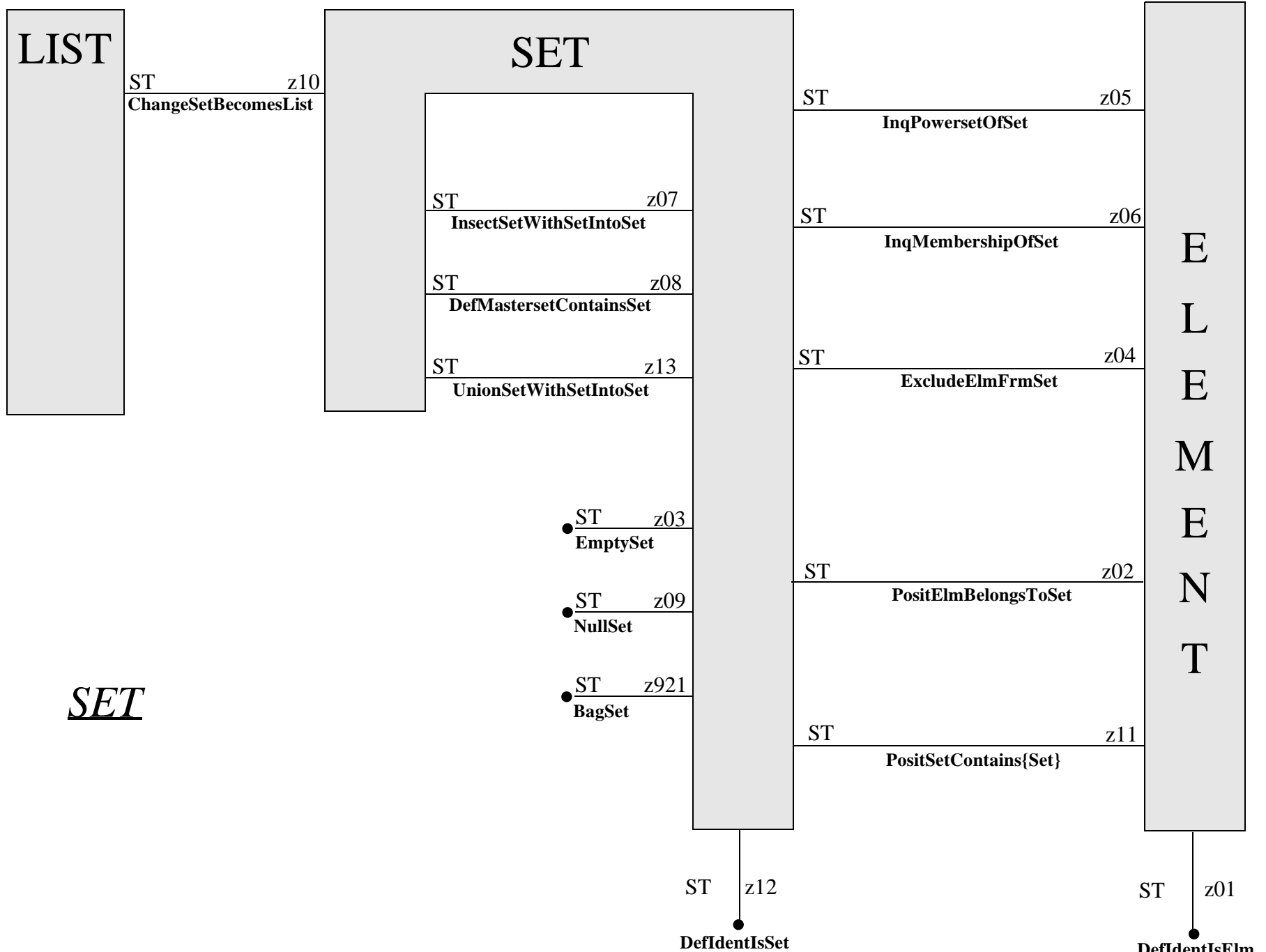

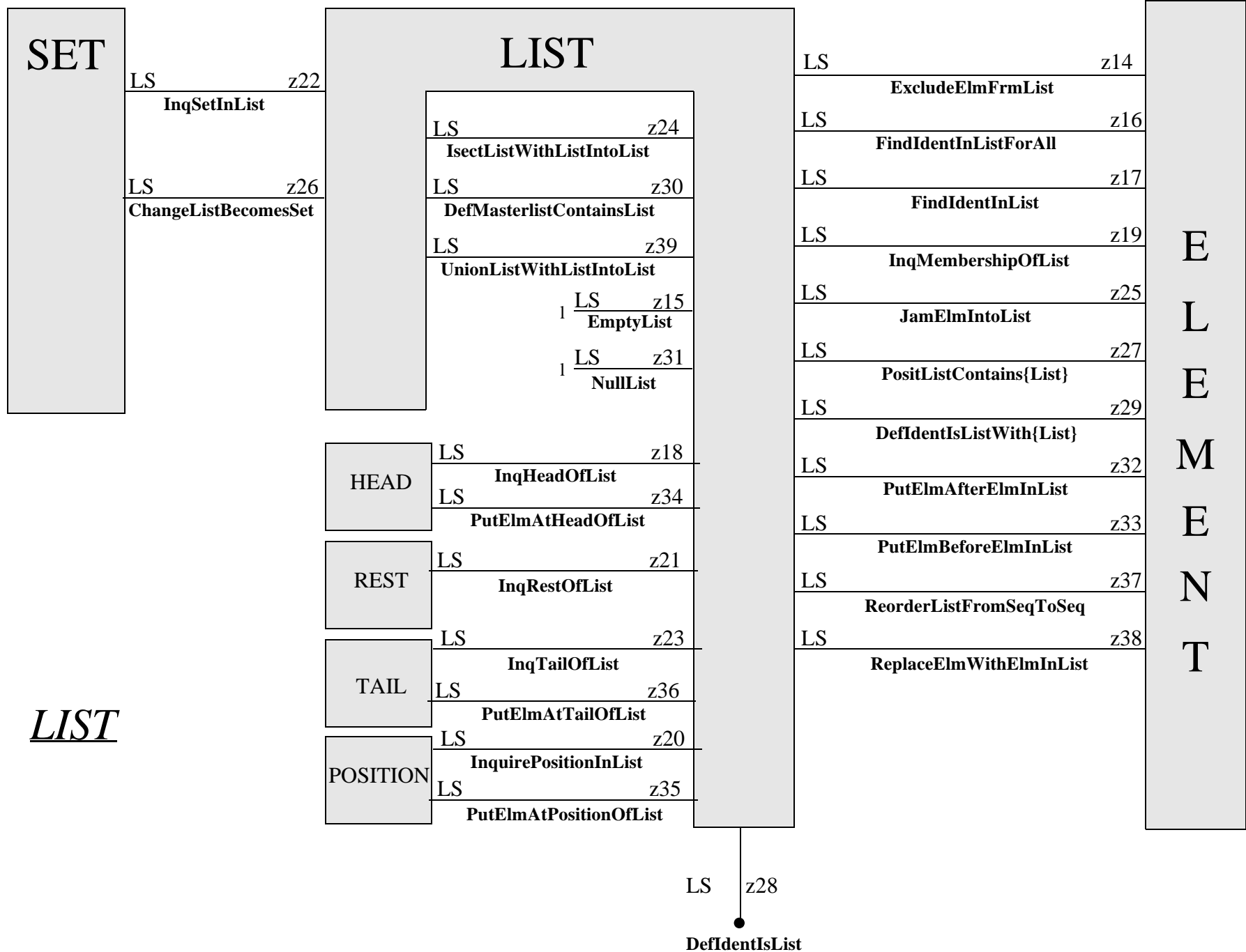

Integral Software Engineering Methods (ISEM) --- Entity Relation Diagram For ISEM Language

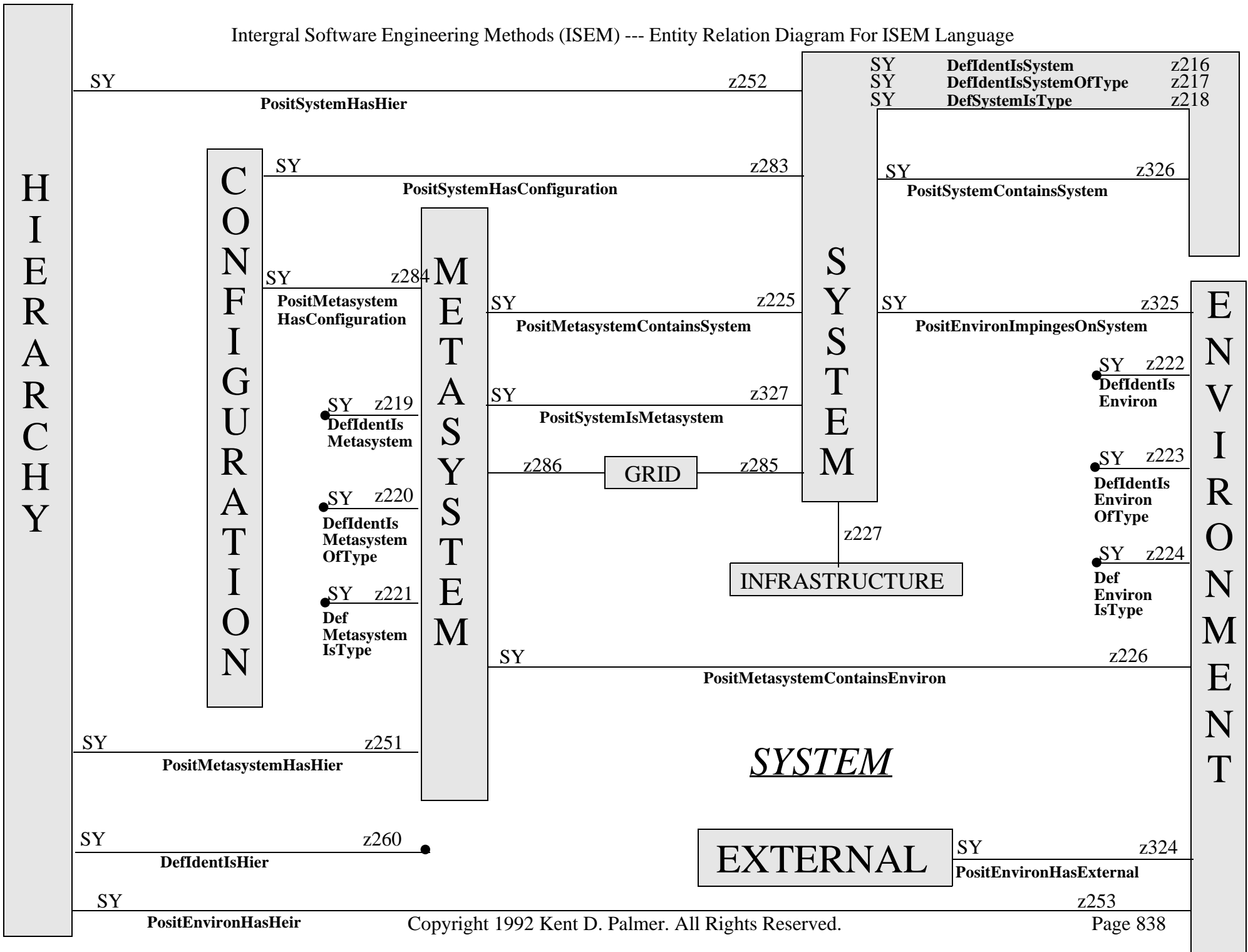

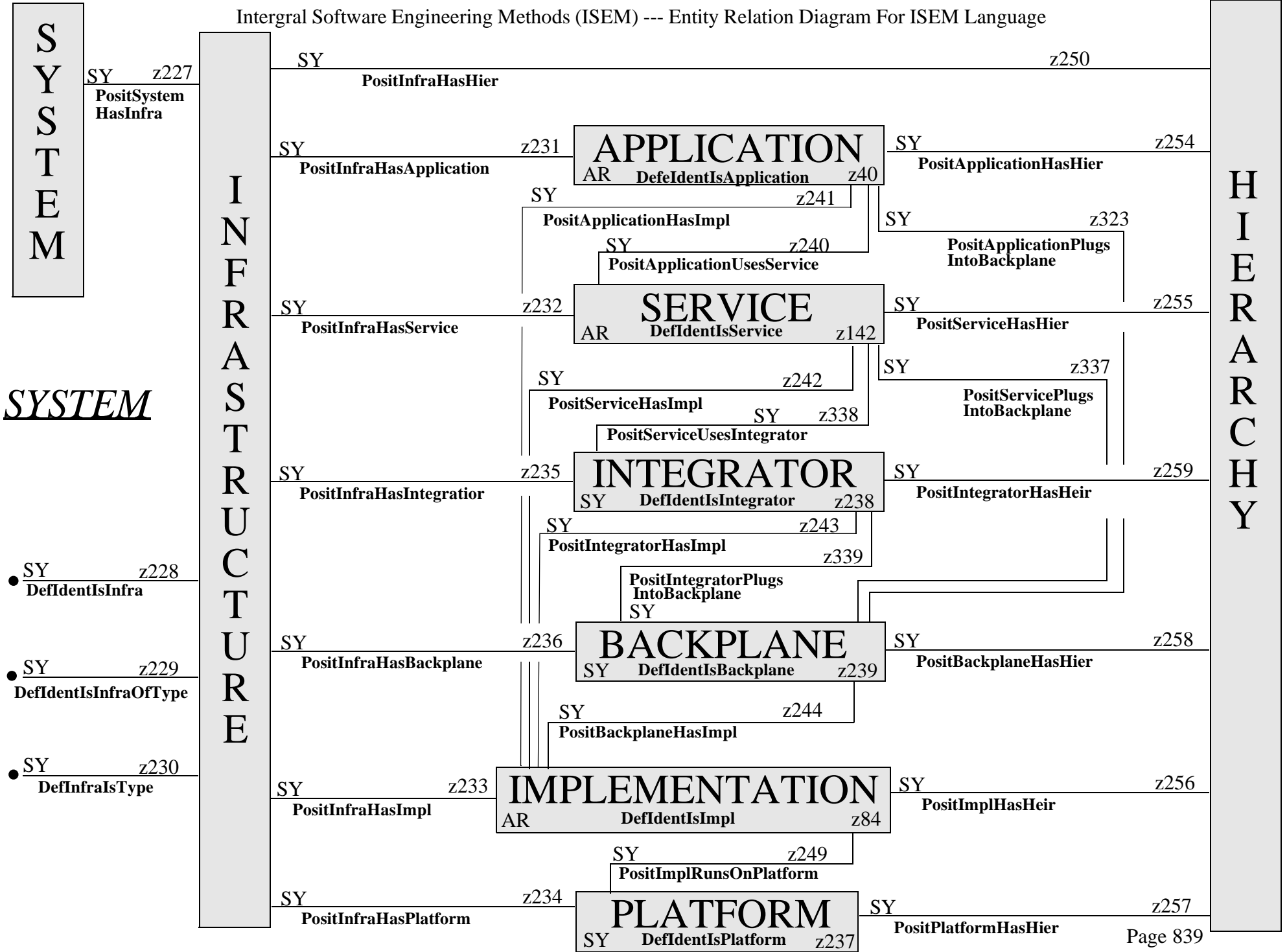

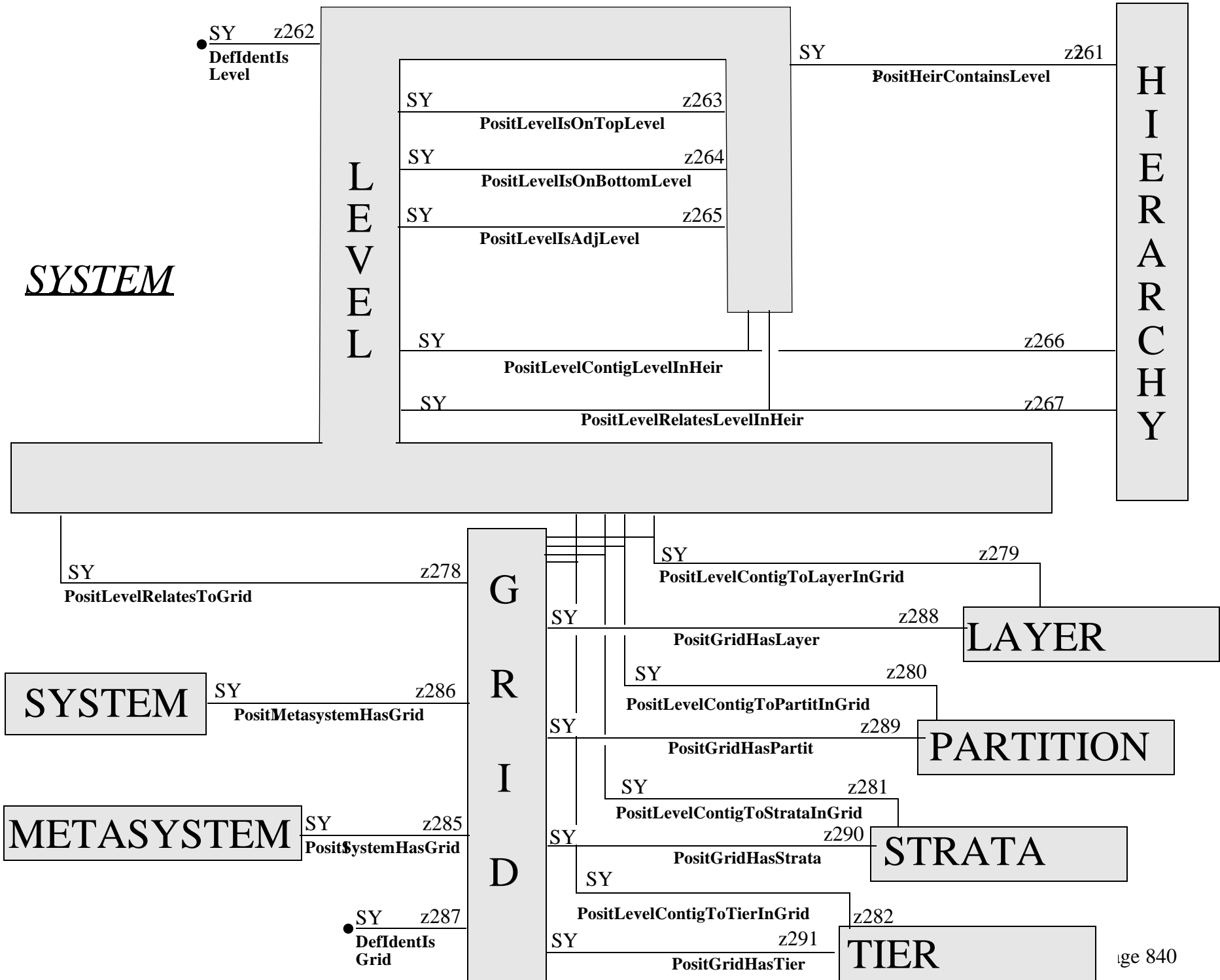

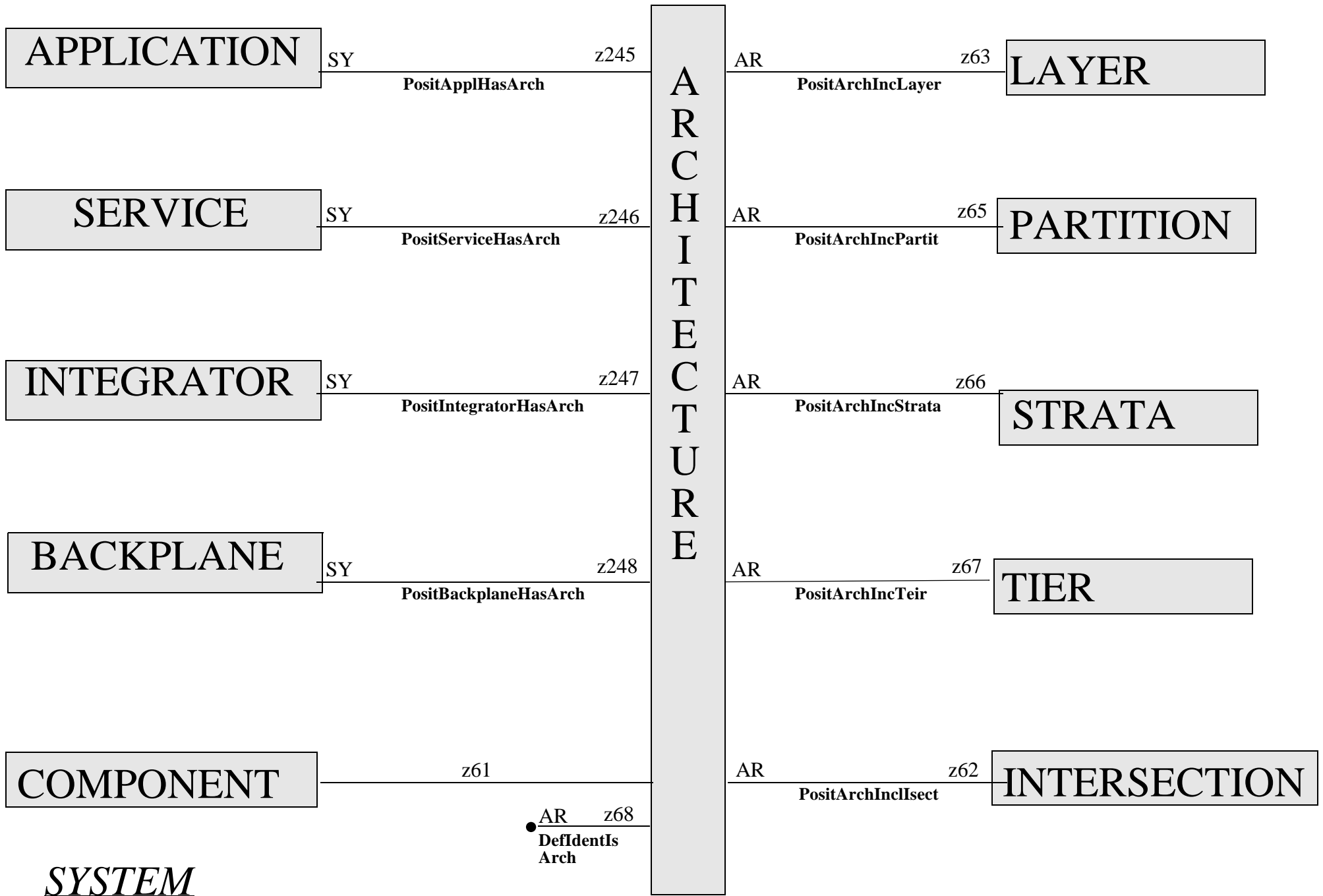

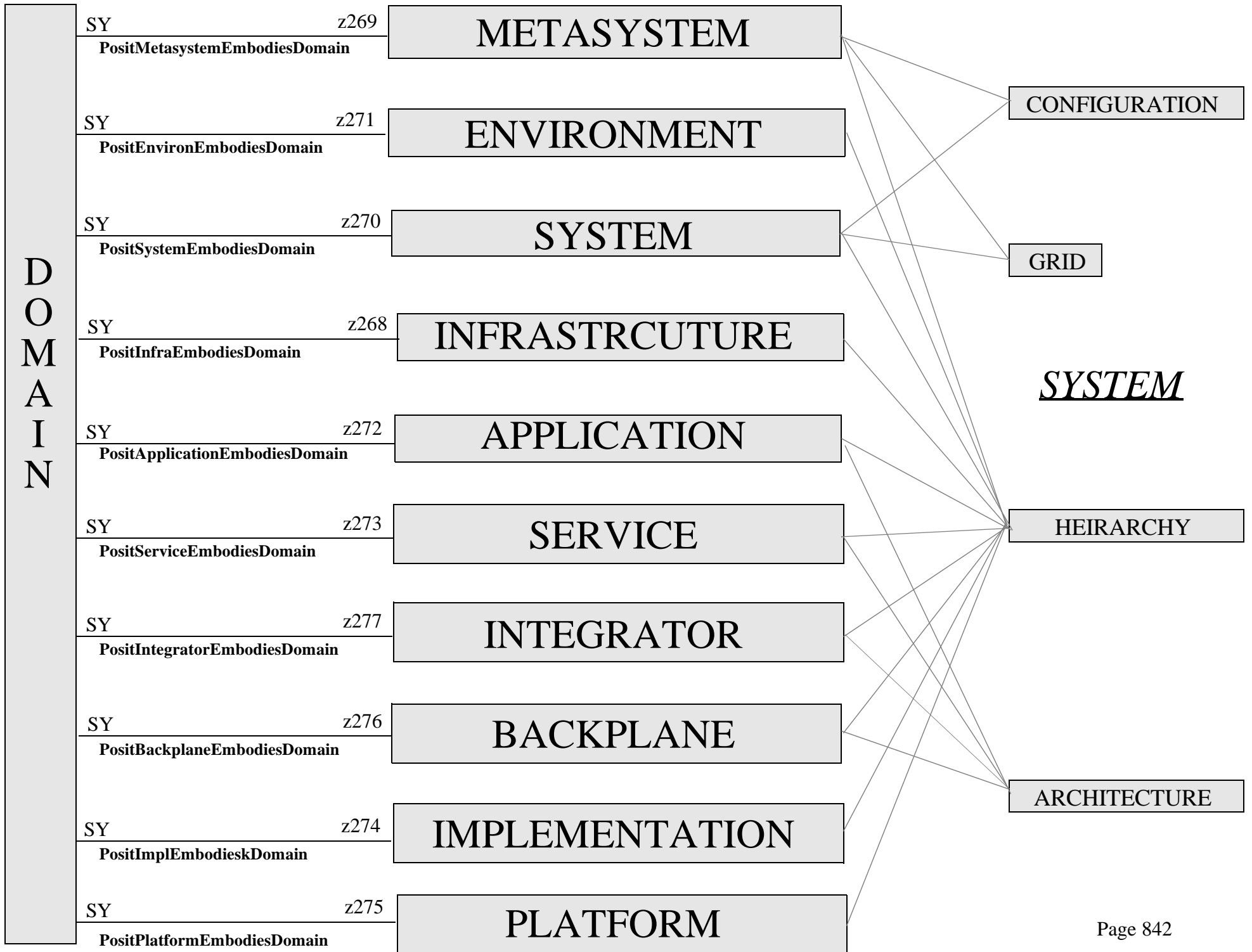



DM  
DM  
DM  
  
D  
  
O  
  
M  
  
A  
  
I  
  
N

C  
O  
N  
F  
I  
G  
U  
R  
A  
T  
I  
O  
N

DM z161 **GLOSSARY** DM z180  
PositDomainHasGlossary PositGlossaryHasConfig  
DM DefIdentIsGlossary z167

DM z157 DefIdentIsDomain  
DM z158 DefIdentIsDomainOfType  
DM z159 DefDomainIsType  
DM z206 **DEFINITION** DM z208 **TEXT**  
PositGlossaryHasDefinition PositDefinitionHasText  
DM DefIdentIsDefinition z207

DM z160 **TAXONOMY** DM z179  
PositDomainHasTaxonomy PositTaxonomyHasConfig

DM z163 **DOCUMENT** DM z182  
PositDomainHasDocument PositDocumentHasConfig  
DM DefIdentIsDocument z168  
DM DefIdentIsDocumentOfType z172  
DM DefDocumentIsType z176

DM z162 **REPRESENTATION** DM z181  
PositDomainHasRep PositRepHasConfig  
DM DefIdentIsRep z165  
DM DefIdentIsRepOfType z171  
DM DefRepIsType z175

DM z164 **PRODUCT** DM z183  
PositDomainHasProduct PositProductHasConfig  
DM DefIdentIsProduct z169  
DM DefIdentIsProductOfType z173  
DM DefProductIsType z177

DM z331 **SPECIFICATION** DM z184  
PositDomainHasSpec PositSpecHasConfig  
DM DefIdentIsSpec z170  
DM DefIdentIsSpecOfType z174  
DM DefSpecIsType z178

**DOMAIN** DM z209 **REQUIREMENT** DM z332 **TEXT**  
PositSpecHasReq PositReqHasText  
DM z214 PositAnyidTracesToReq  
DM z215 PositAnyidTracesFromReq  
DM z213 PositAnyidRelateToReq  
DM DefIdentIsReq z210  
DM DefIdentIsReqOfType z211  
DM DefReqIsType z212  
**ANYID**

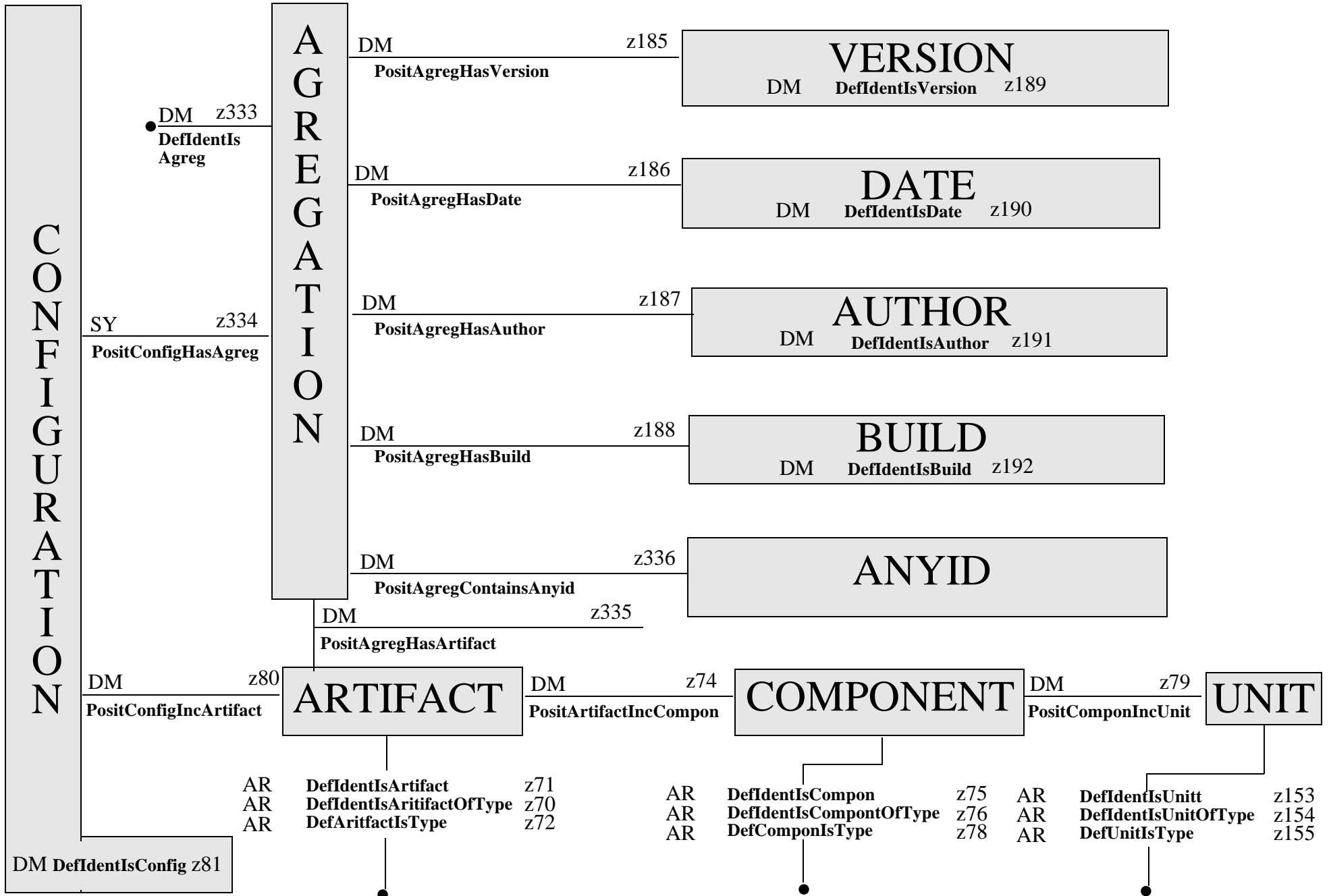

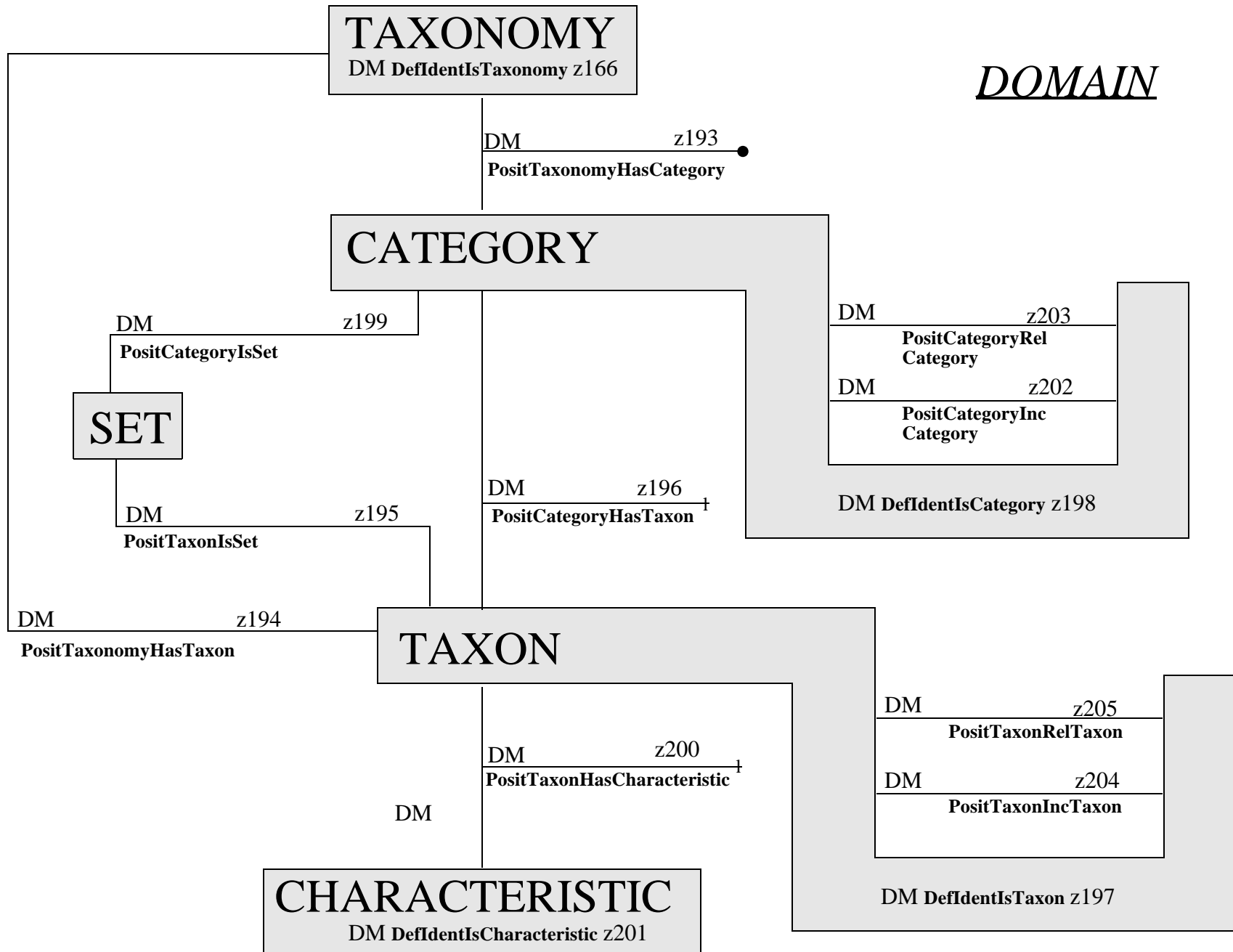

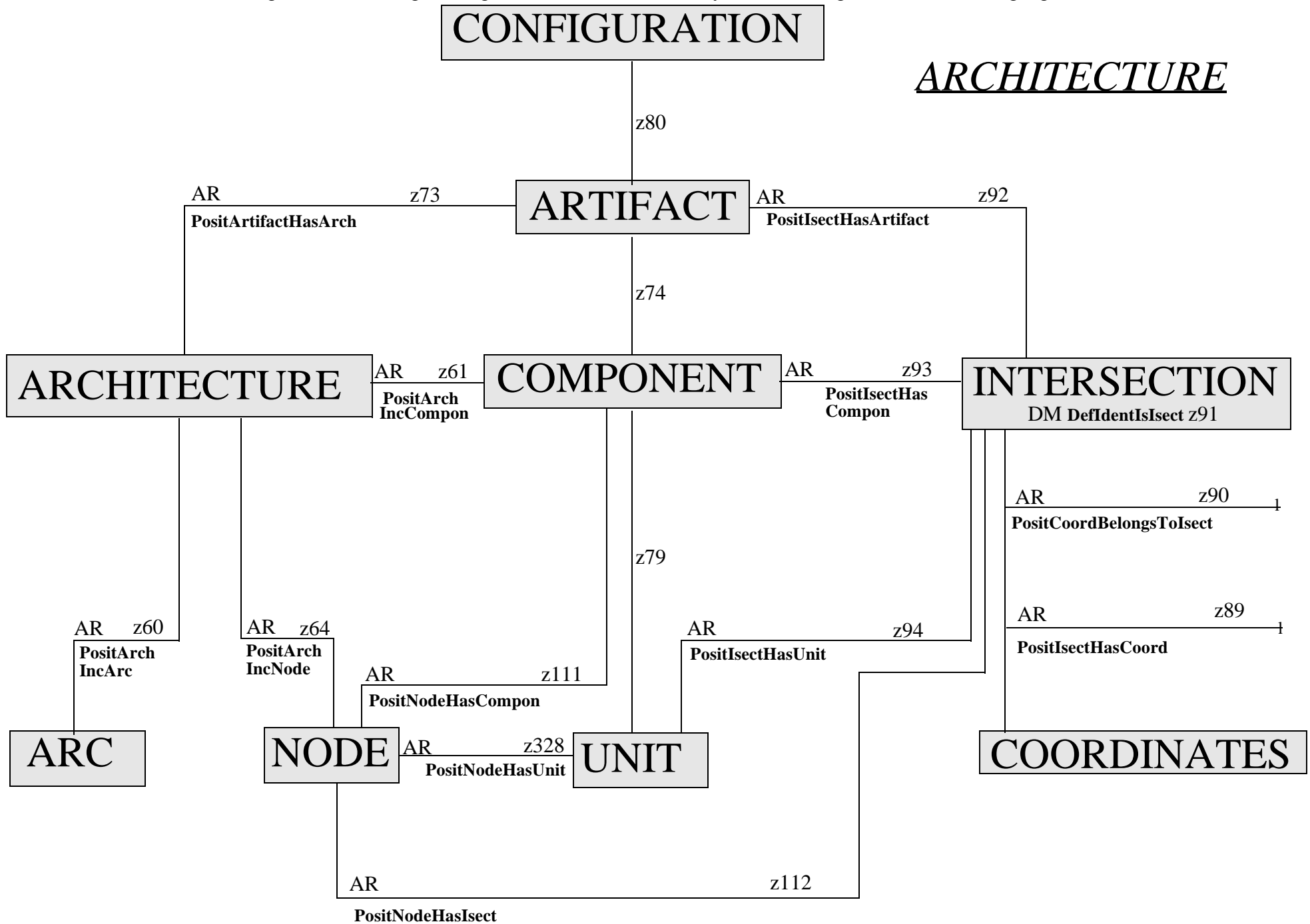

*ARCHITECTURE*

# COMPONENT

# ARCHITECTURE

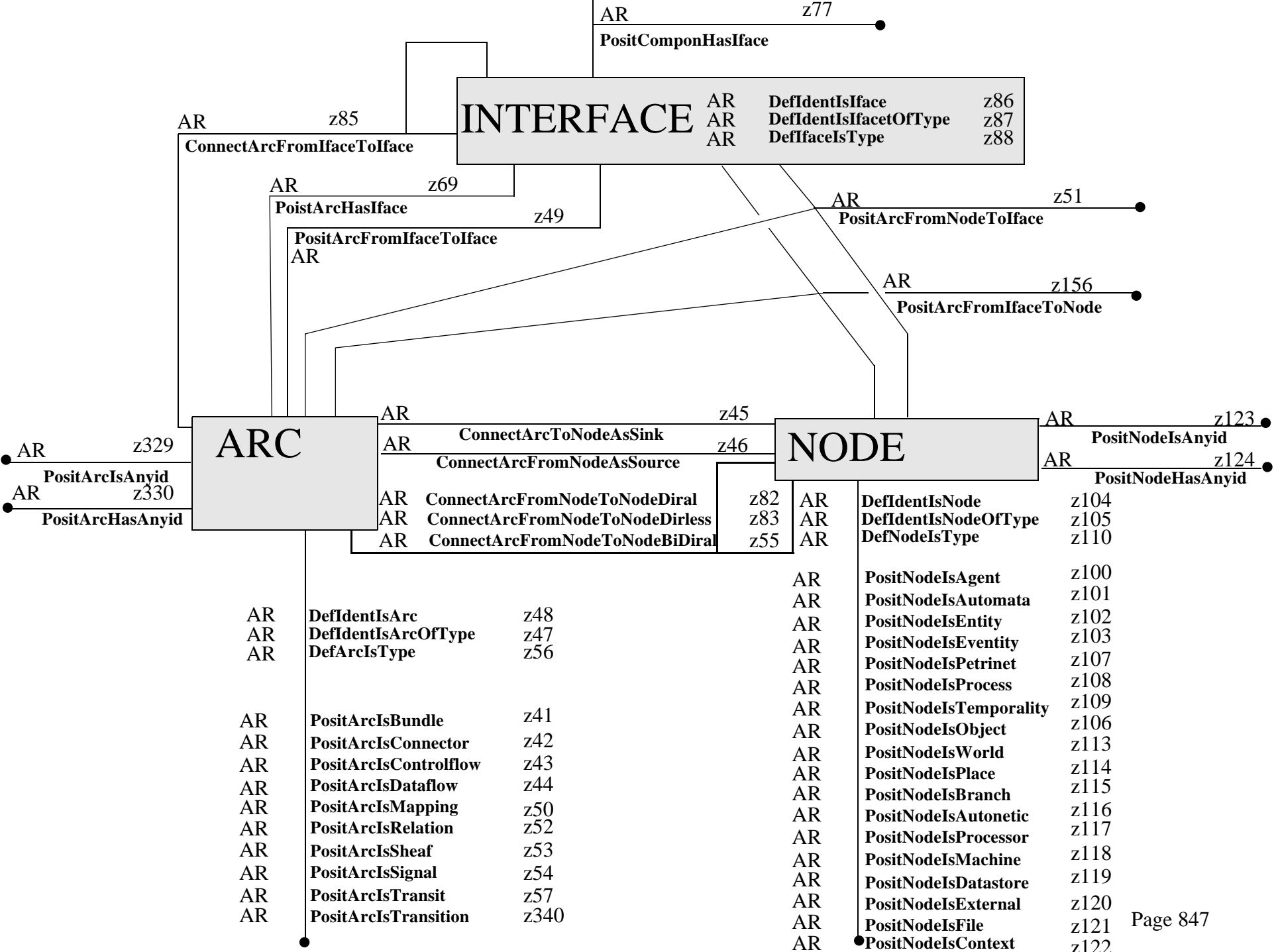

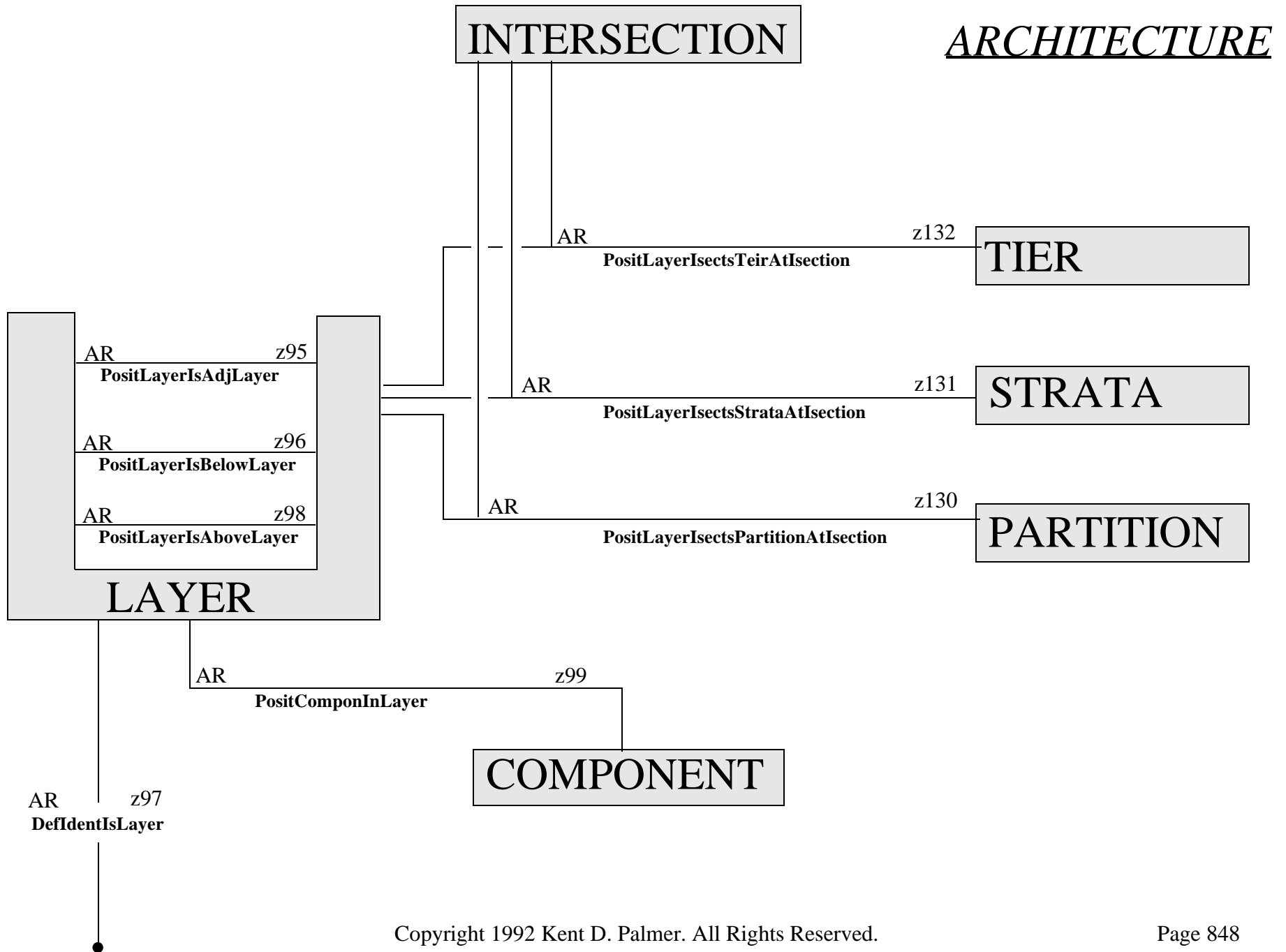

ARCHITECTURE

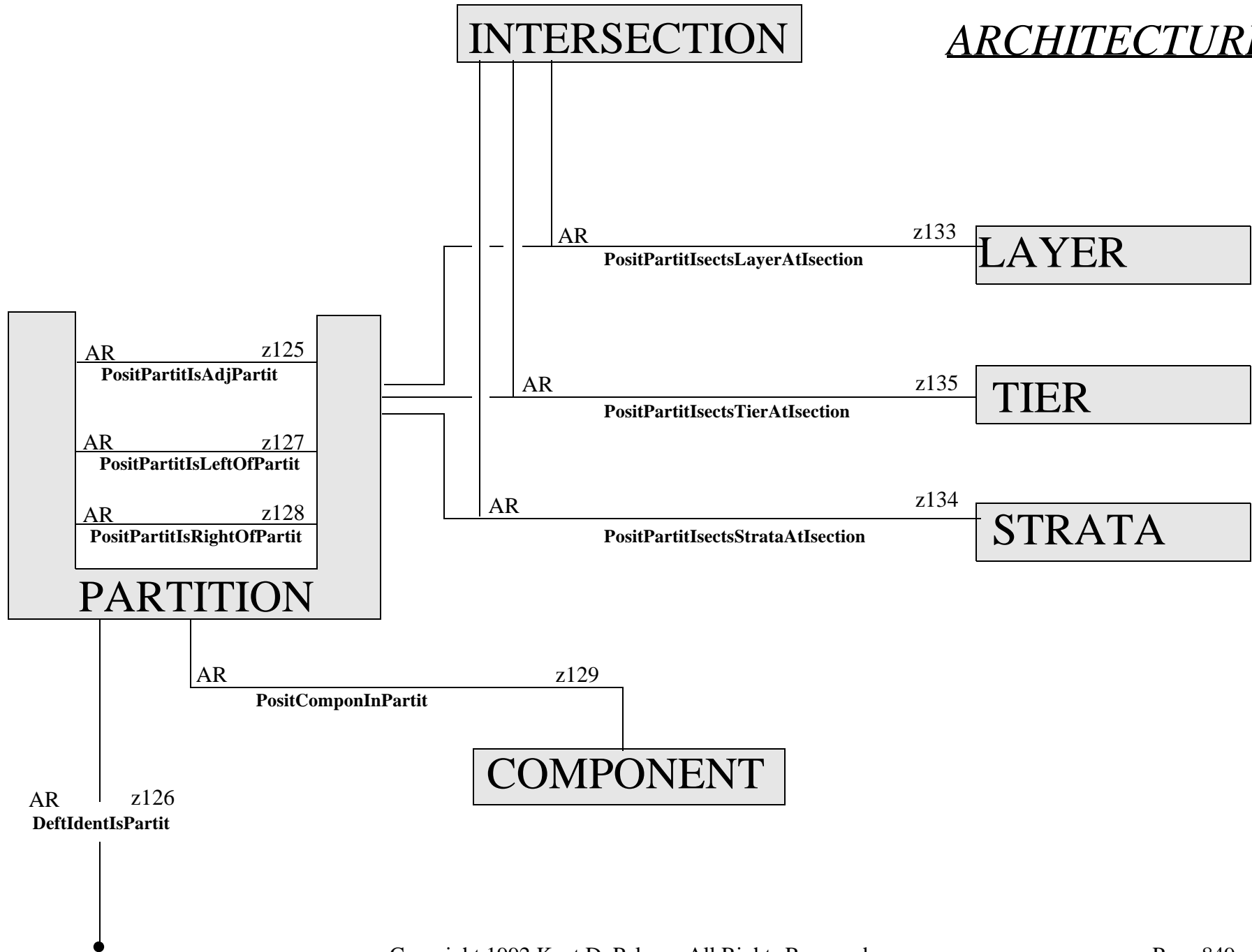

*ARCHITECTURE*

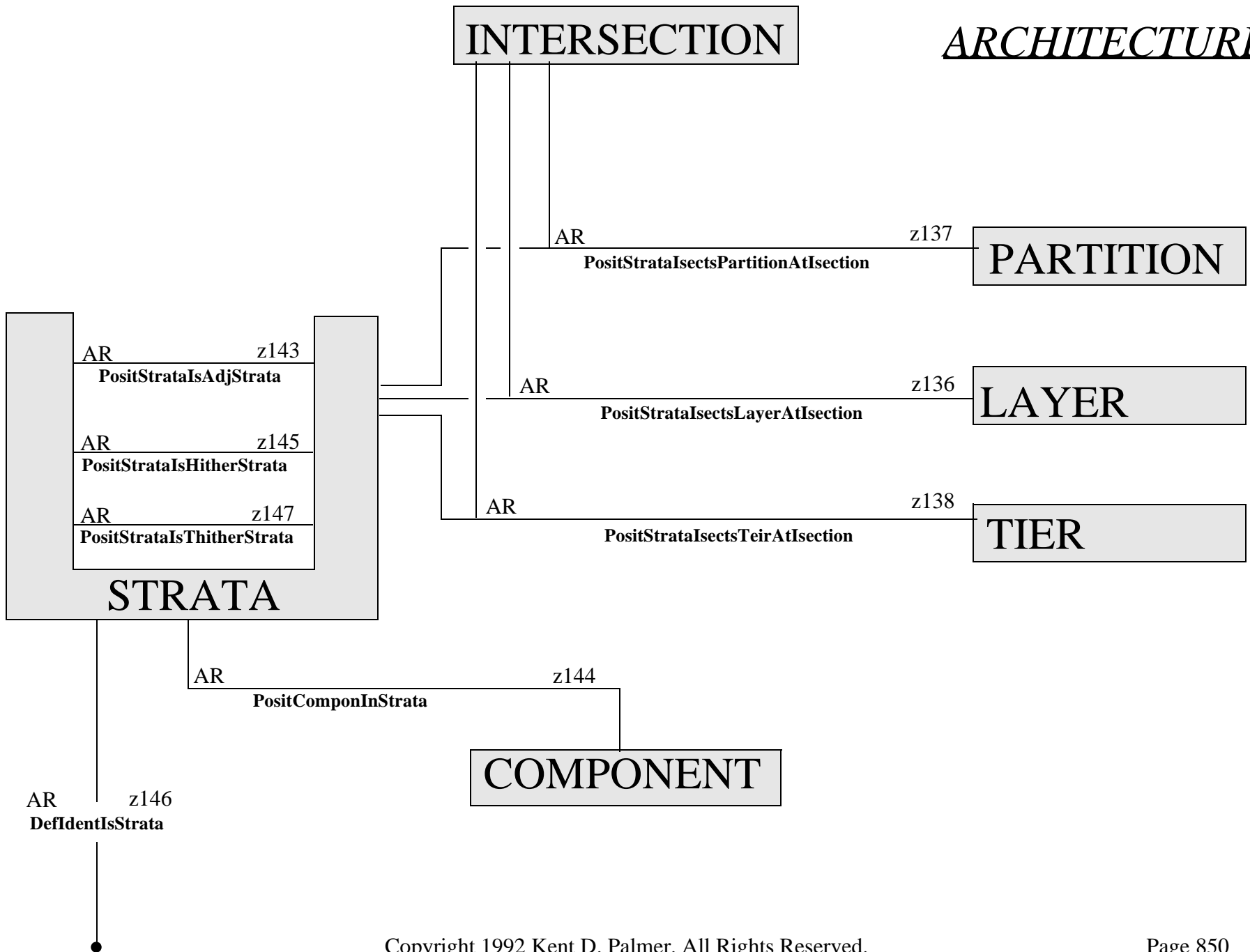



*ARCHITECTURE*

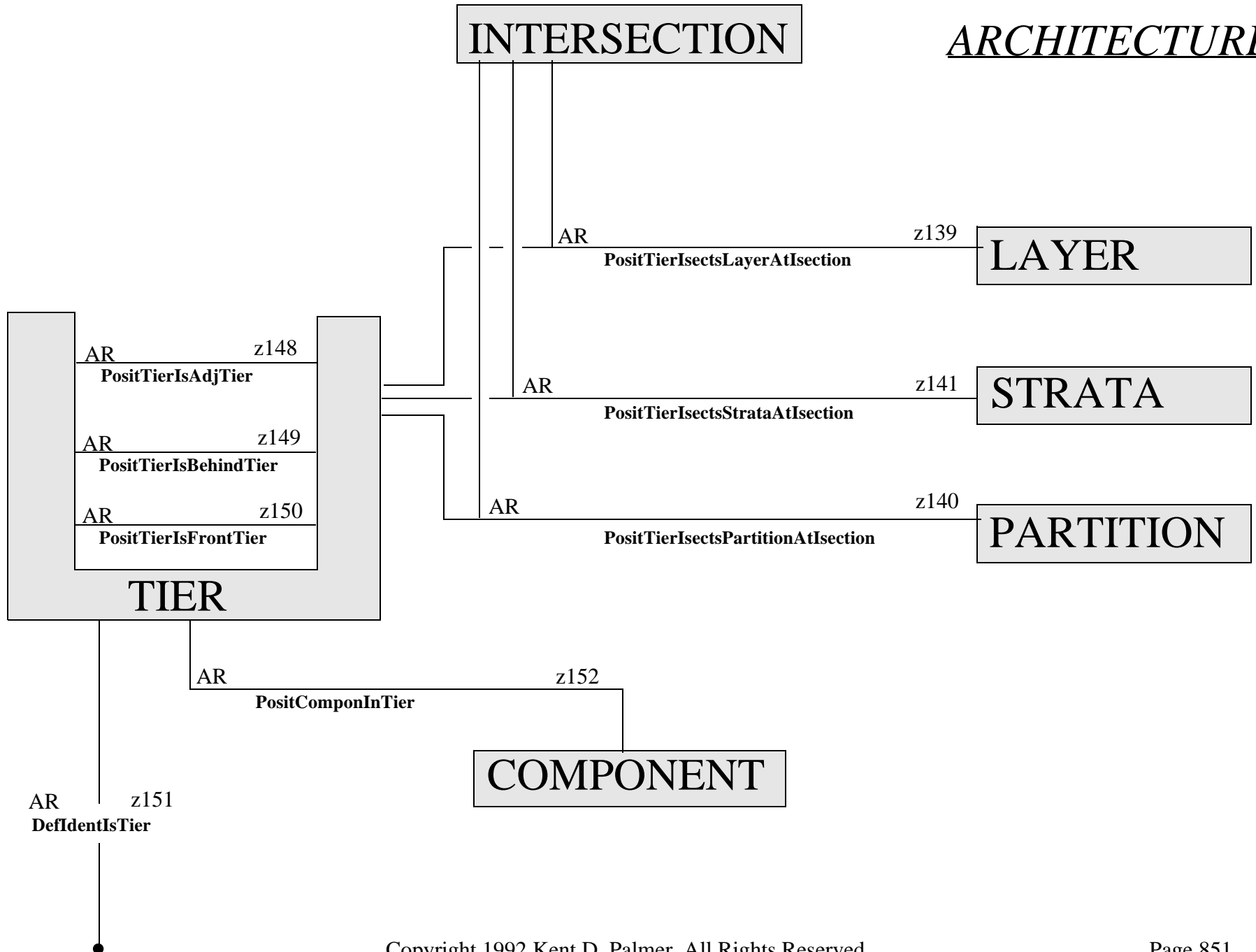

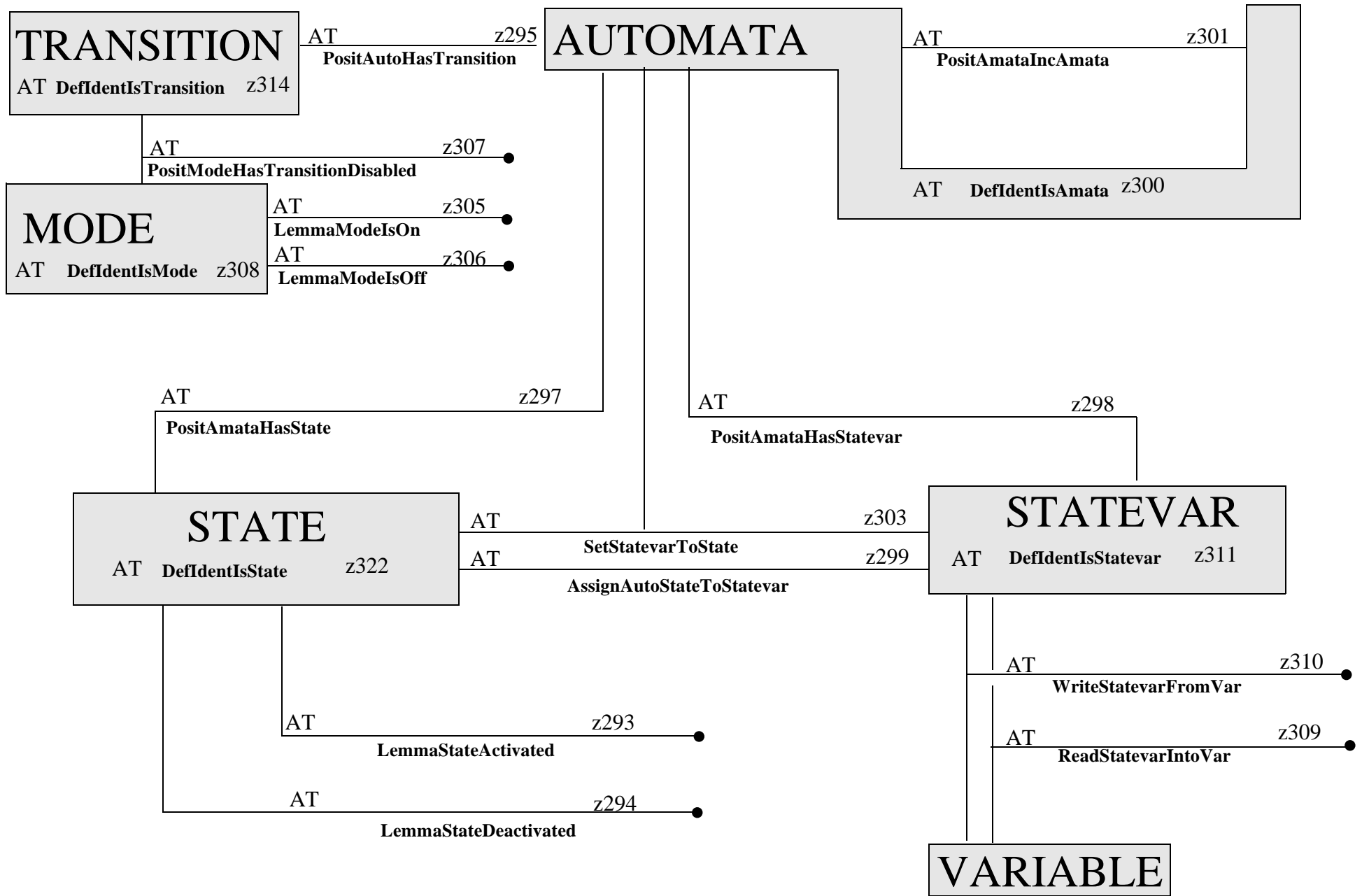

# *AUTOMATA*

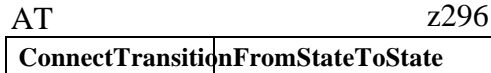
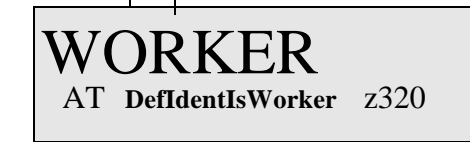
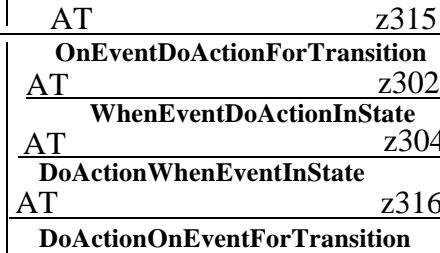
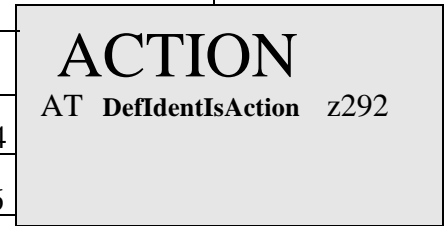

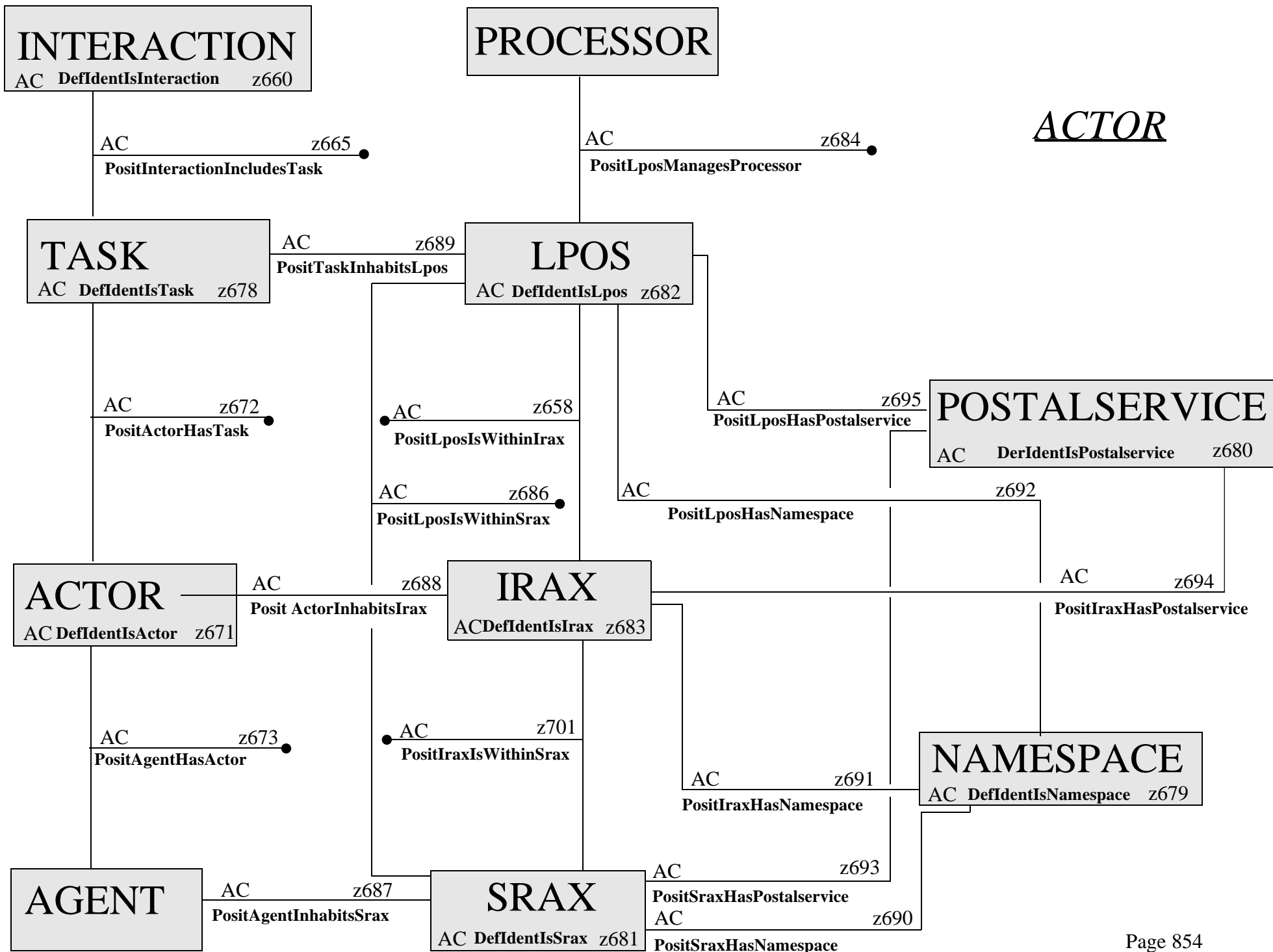

*ACTOR*

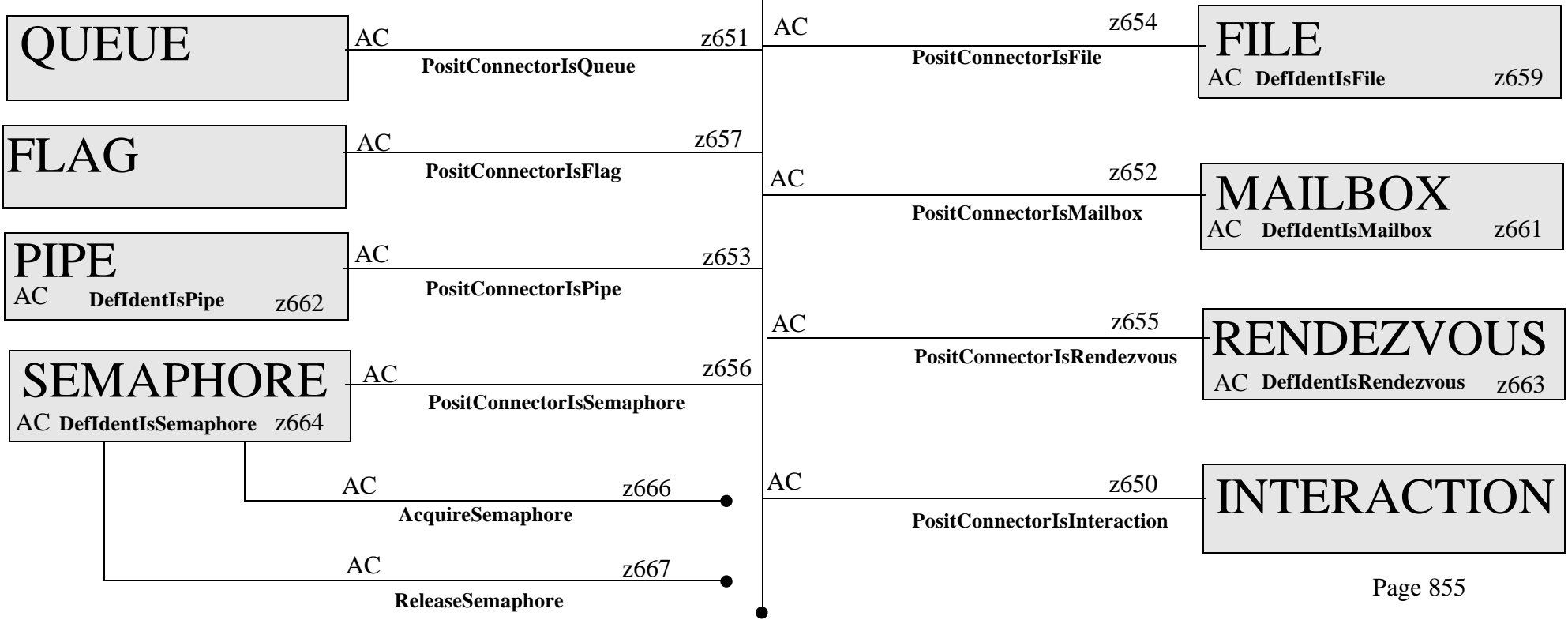
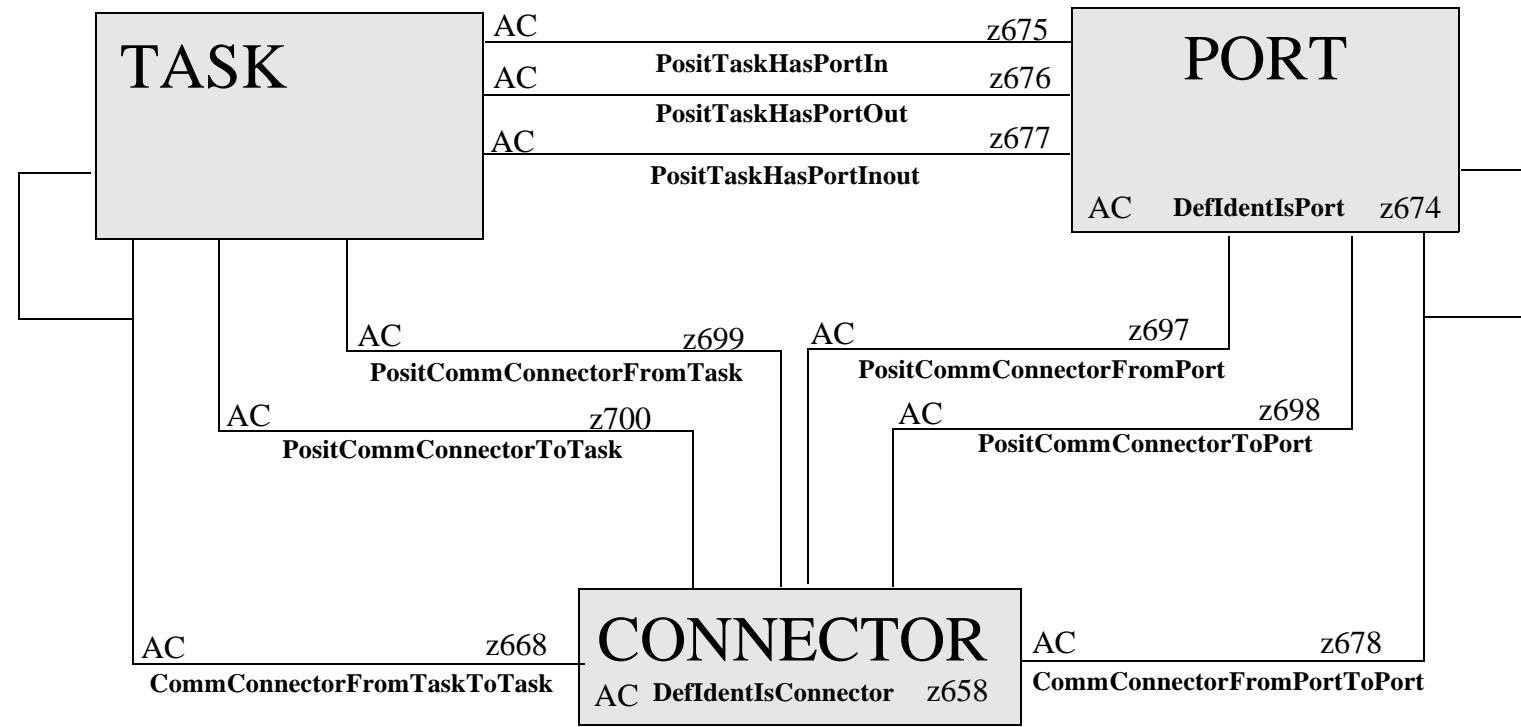

# ACTOR

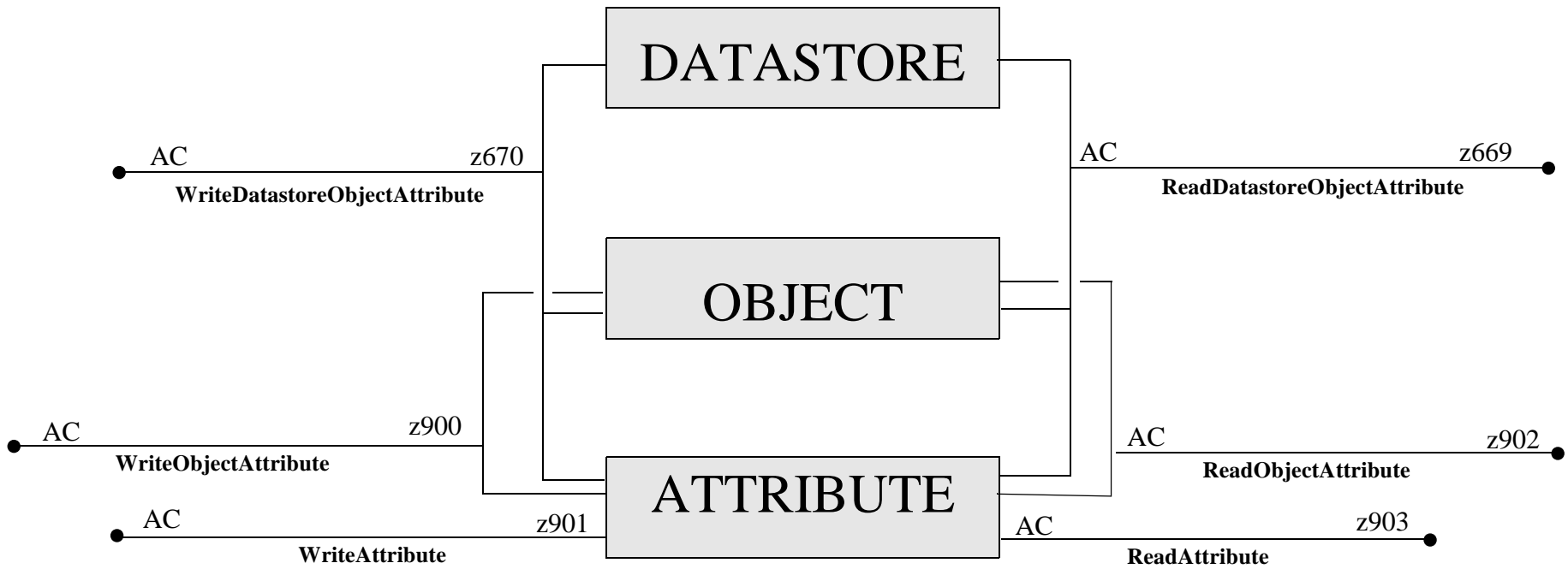

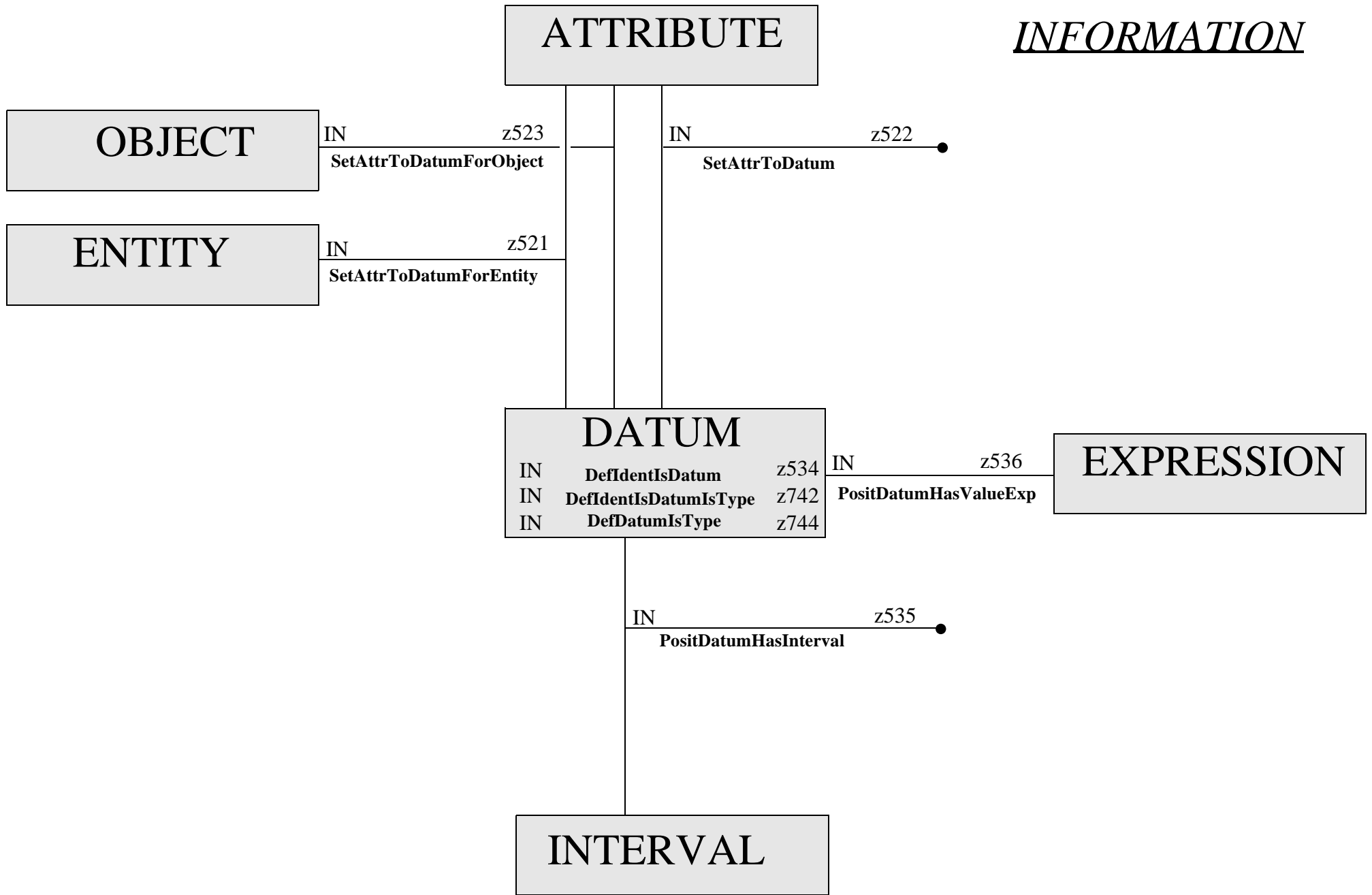

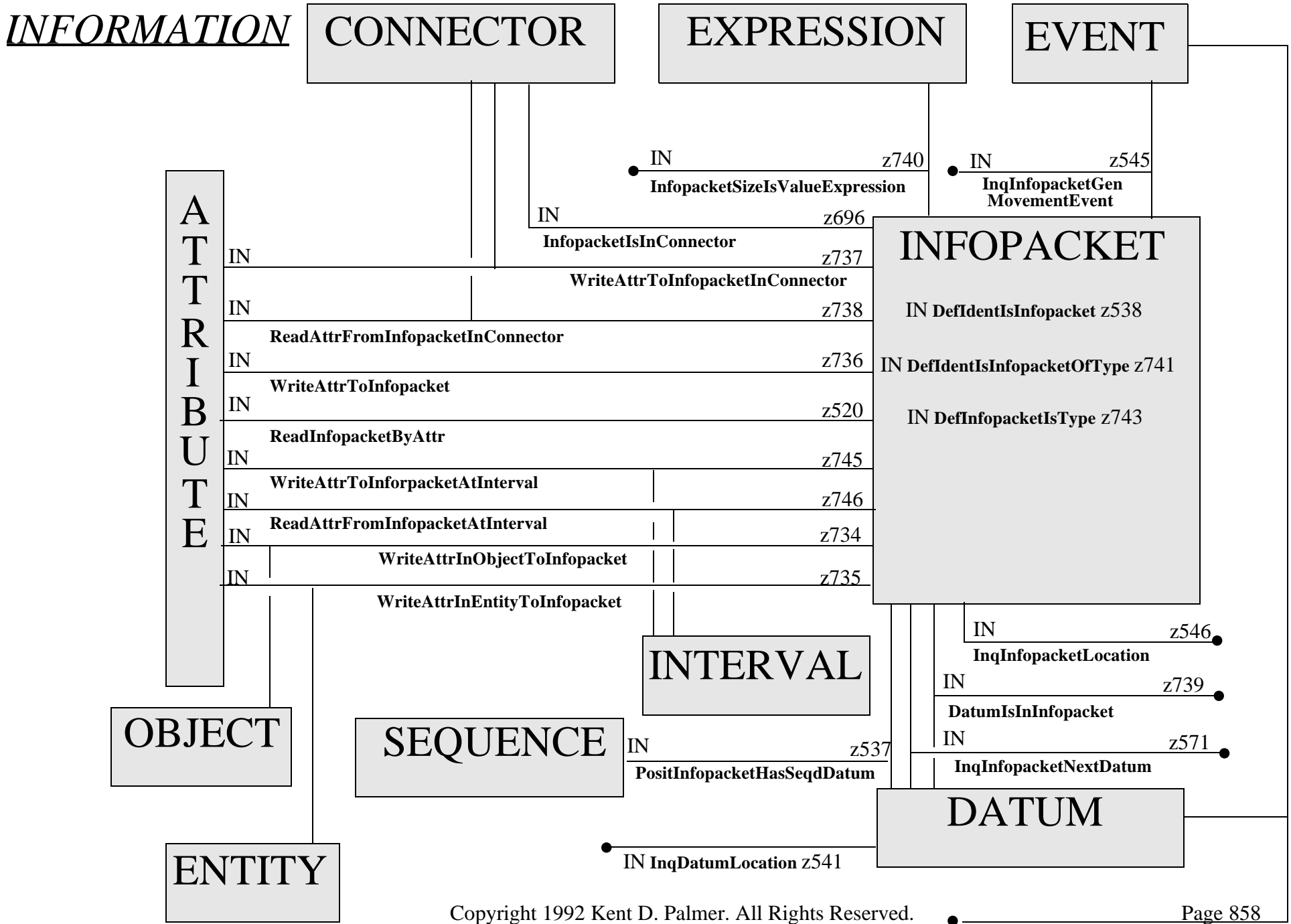



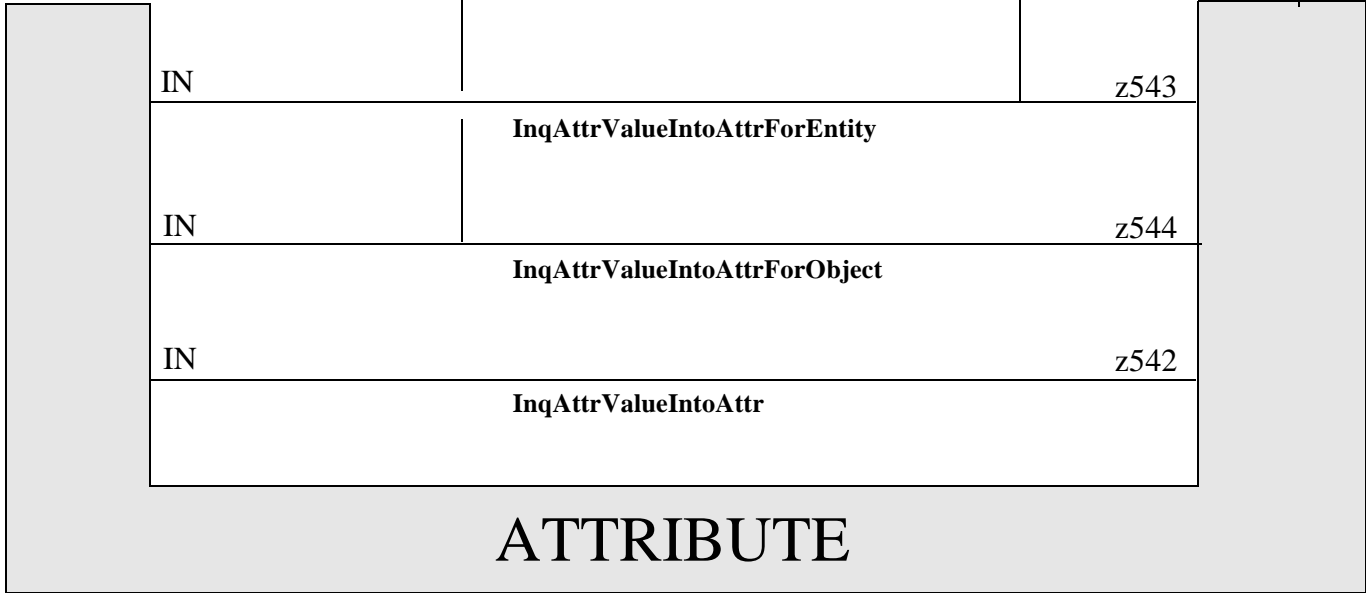
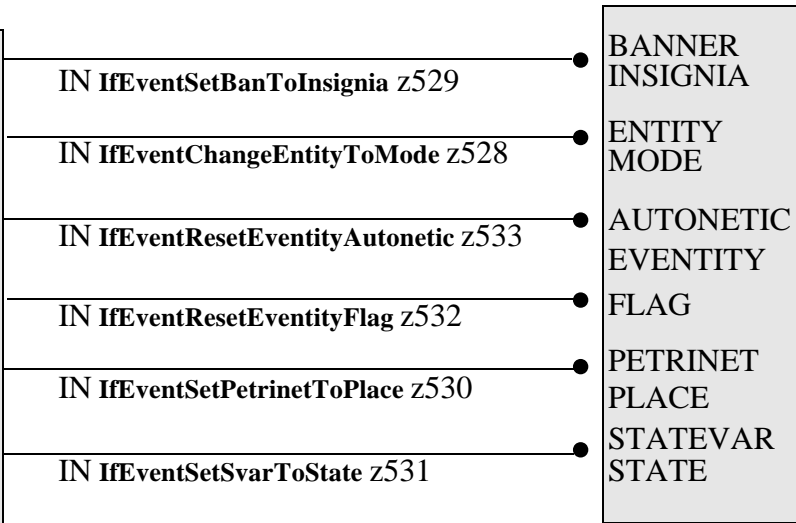
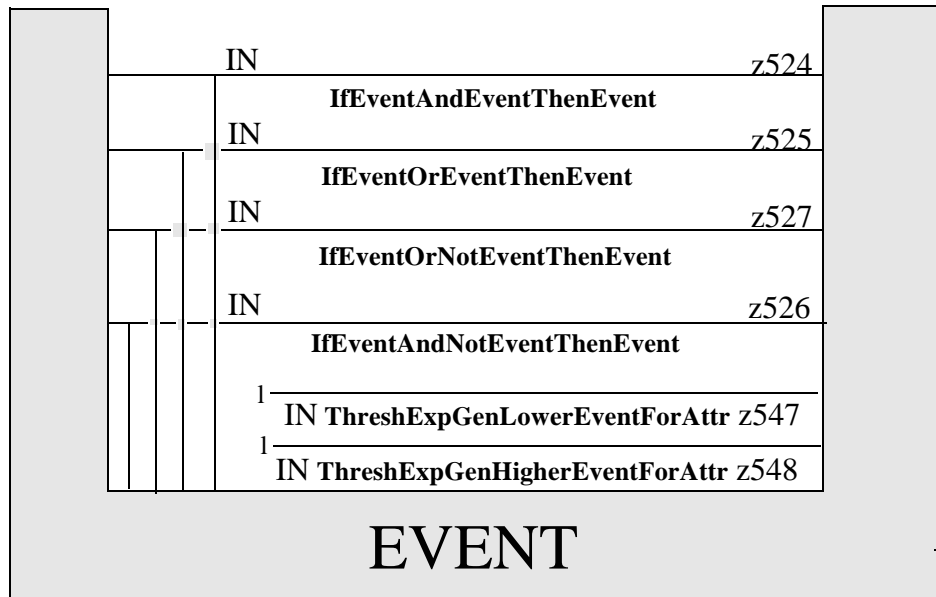

***INFORMATION***

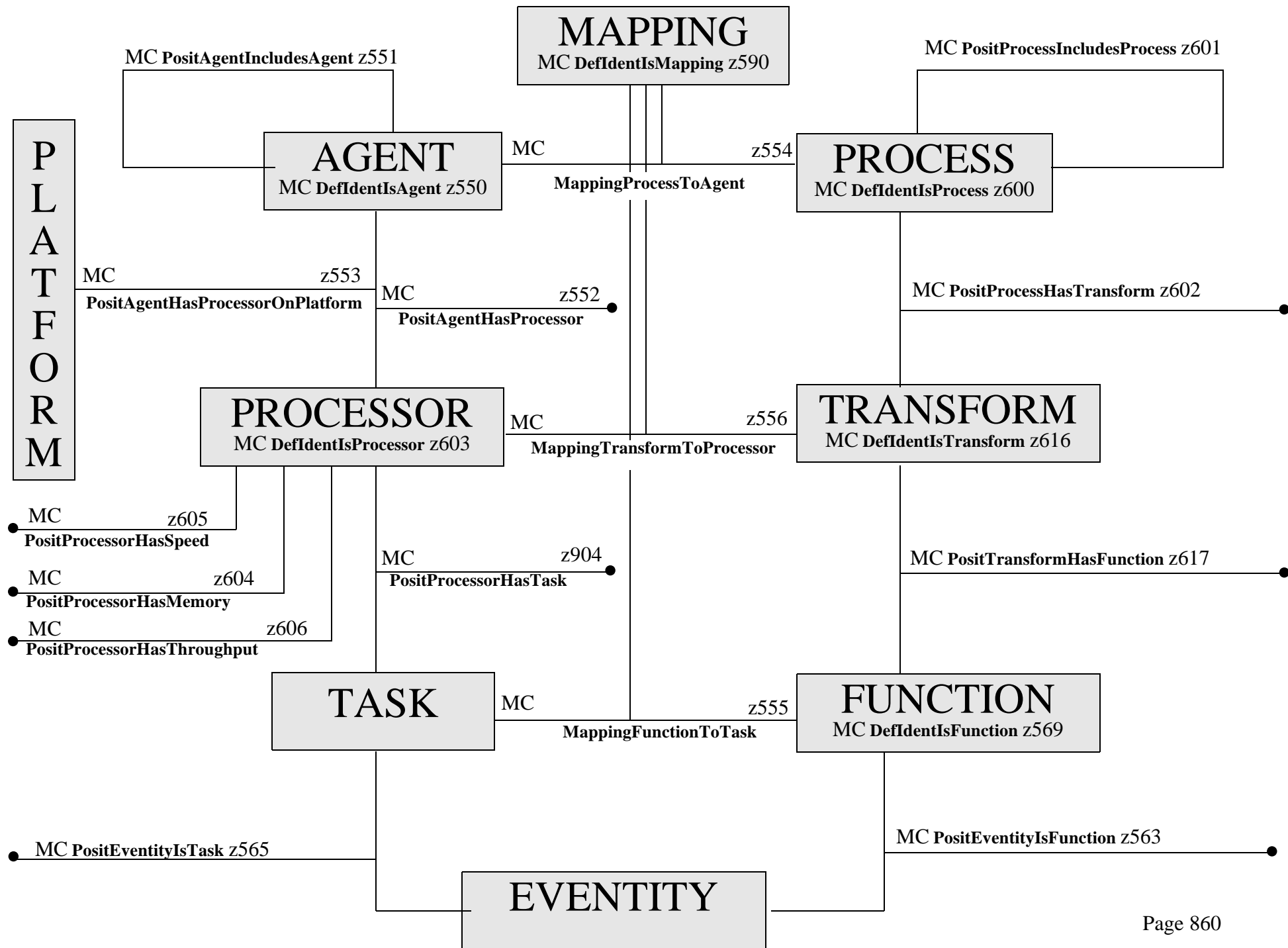

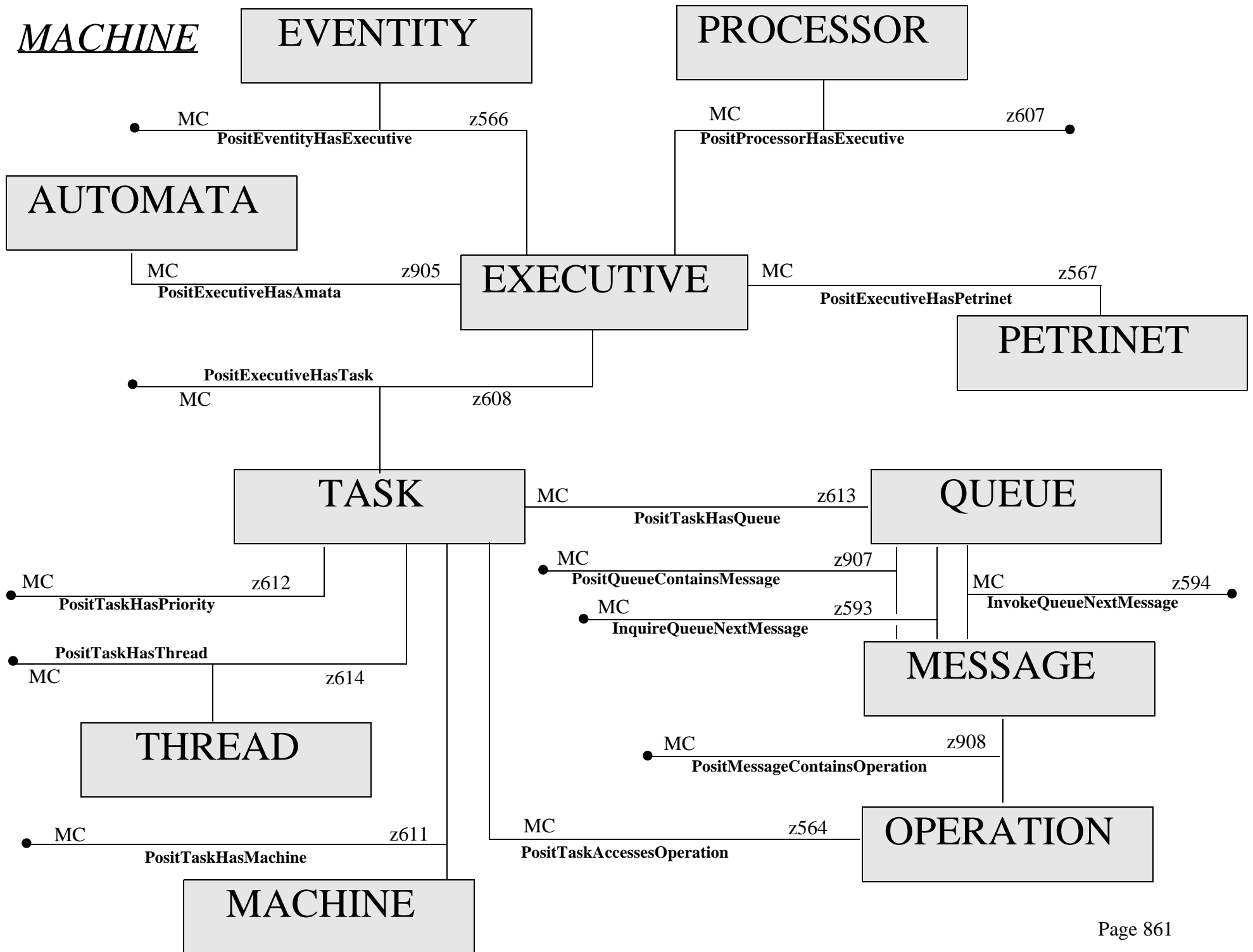

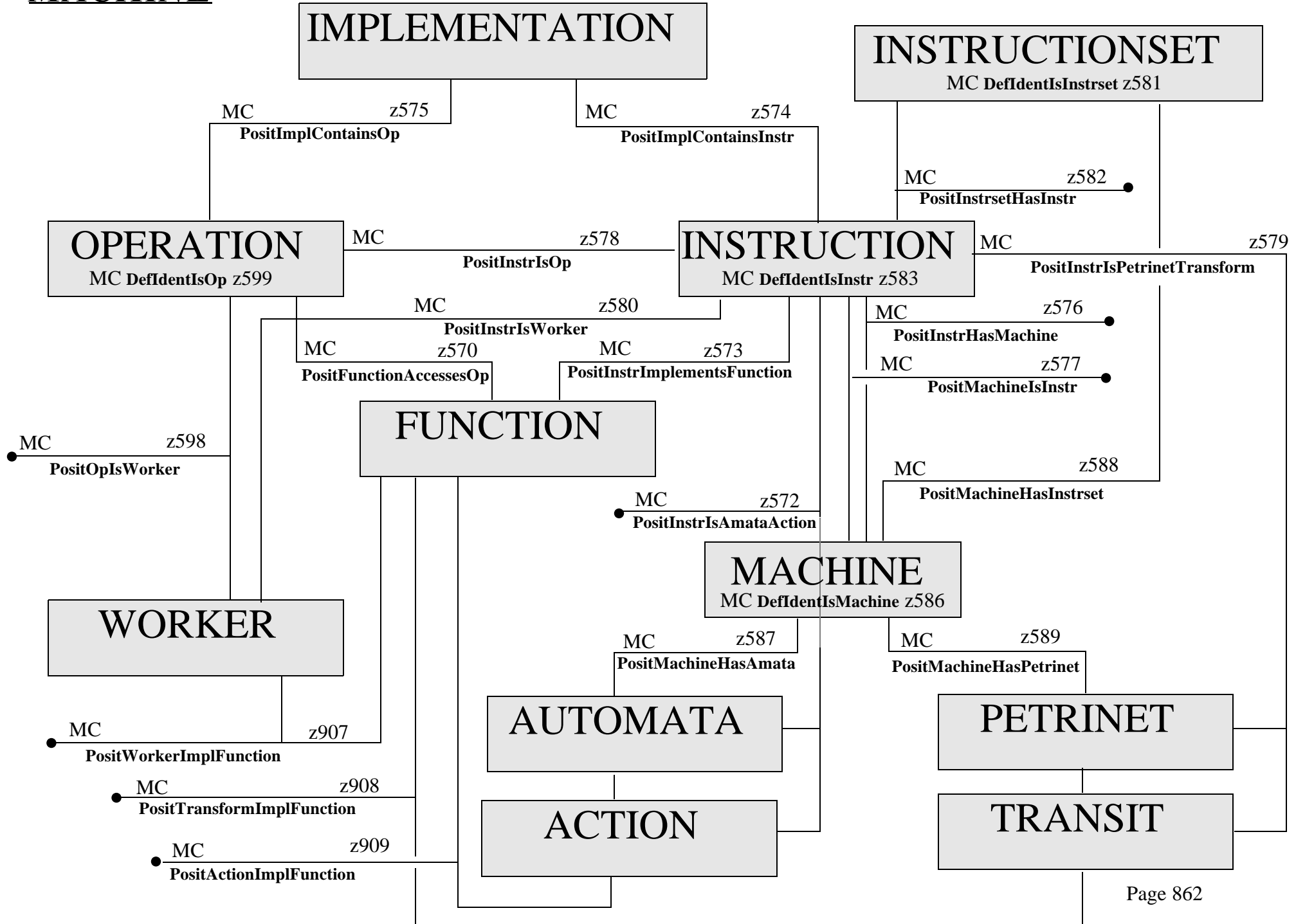

MC FiringInstrSetAmataStateActive z557  
 MC FiringInstrSetBanToInsignia z560  
 MC FiringInstrGenerateEvent z561  
 MC FiringInstrMarkPetrinetPlace z559  
 MC FiringInstrSetSvarToState z558

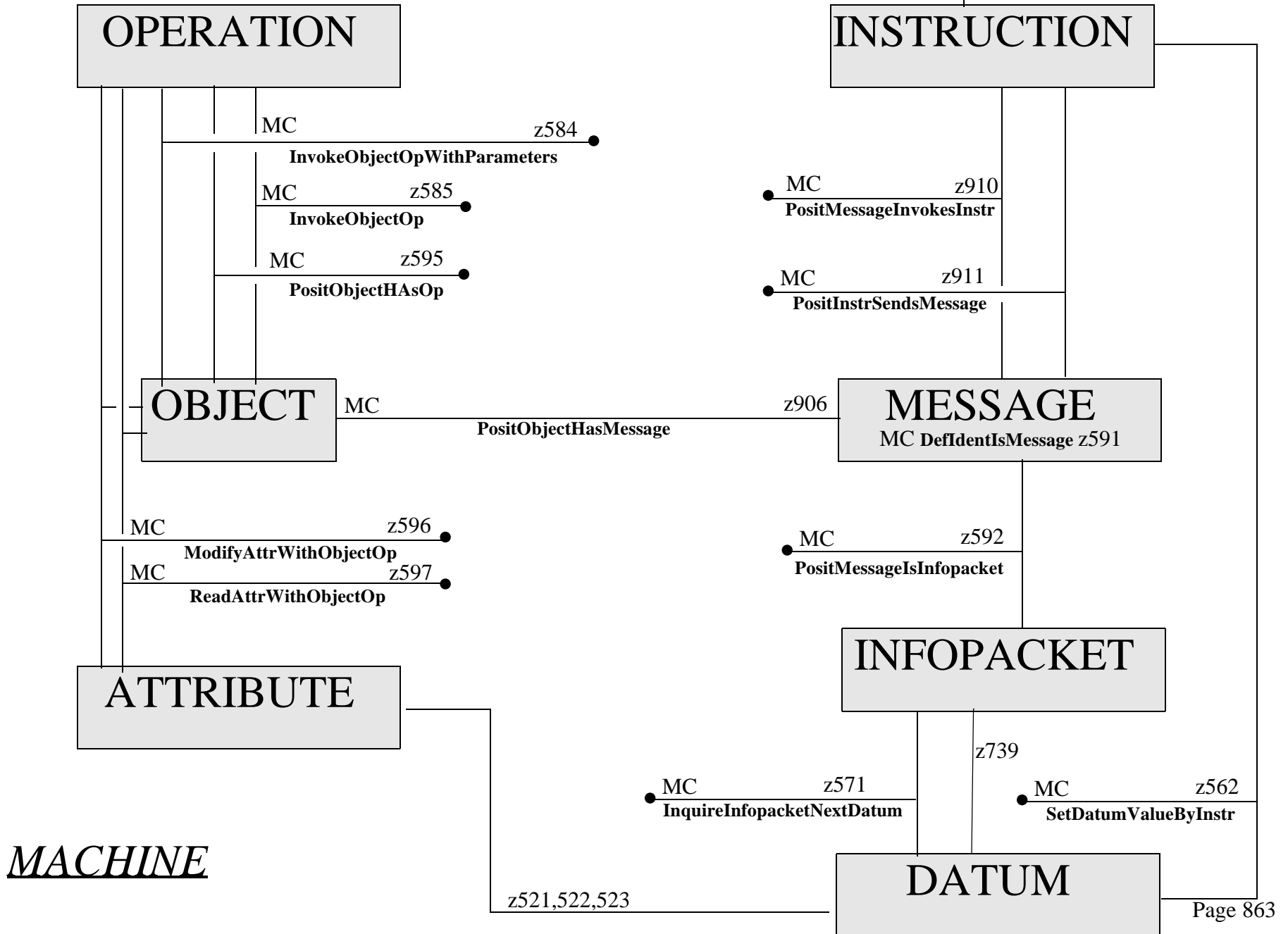

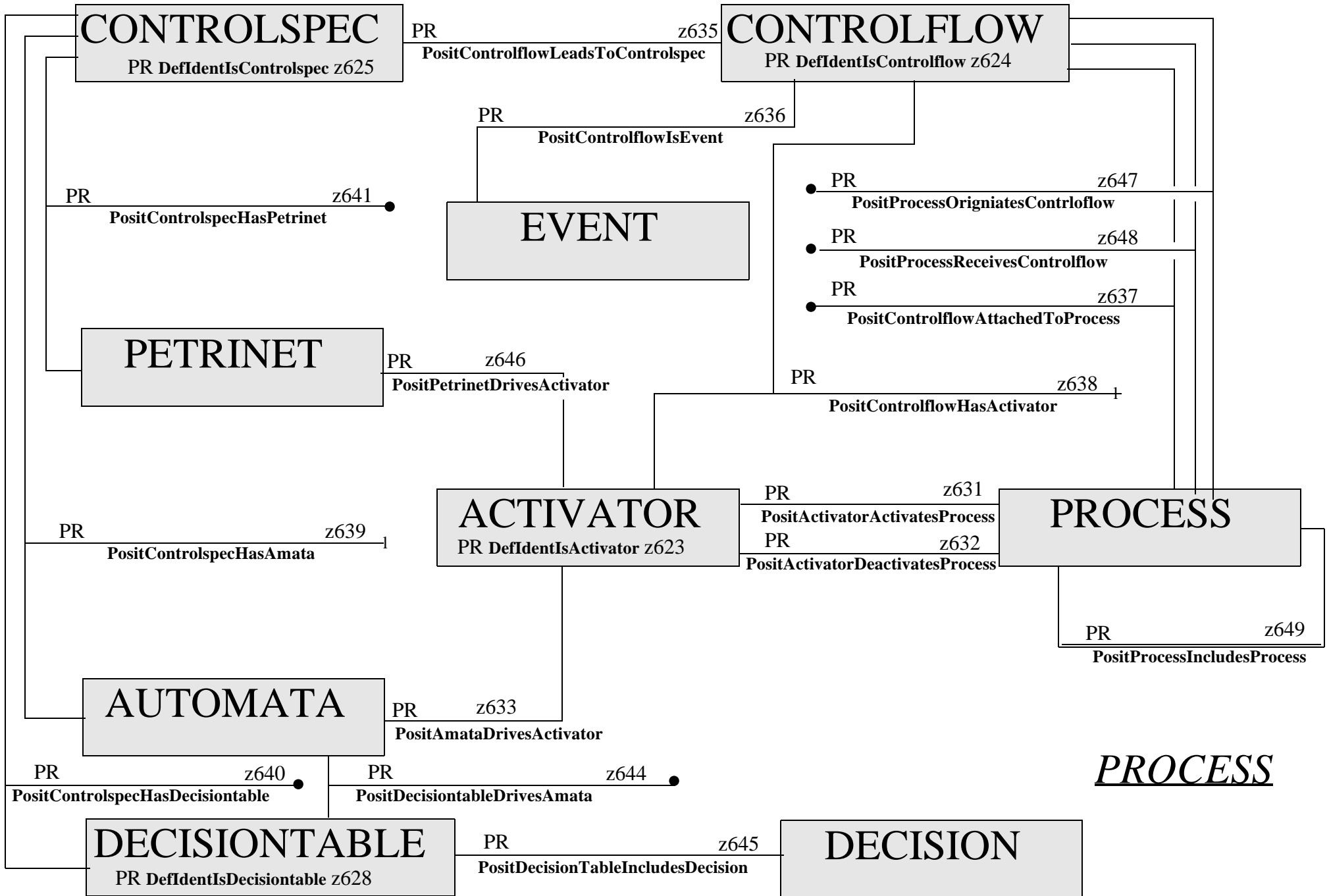

***PROCESS***

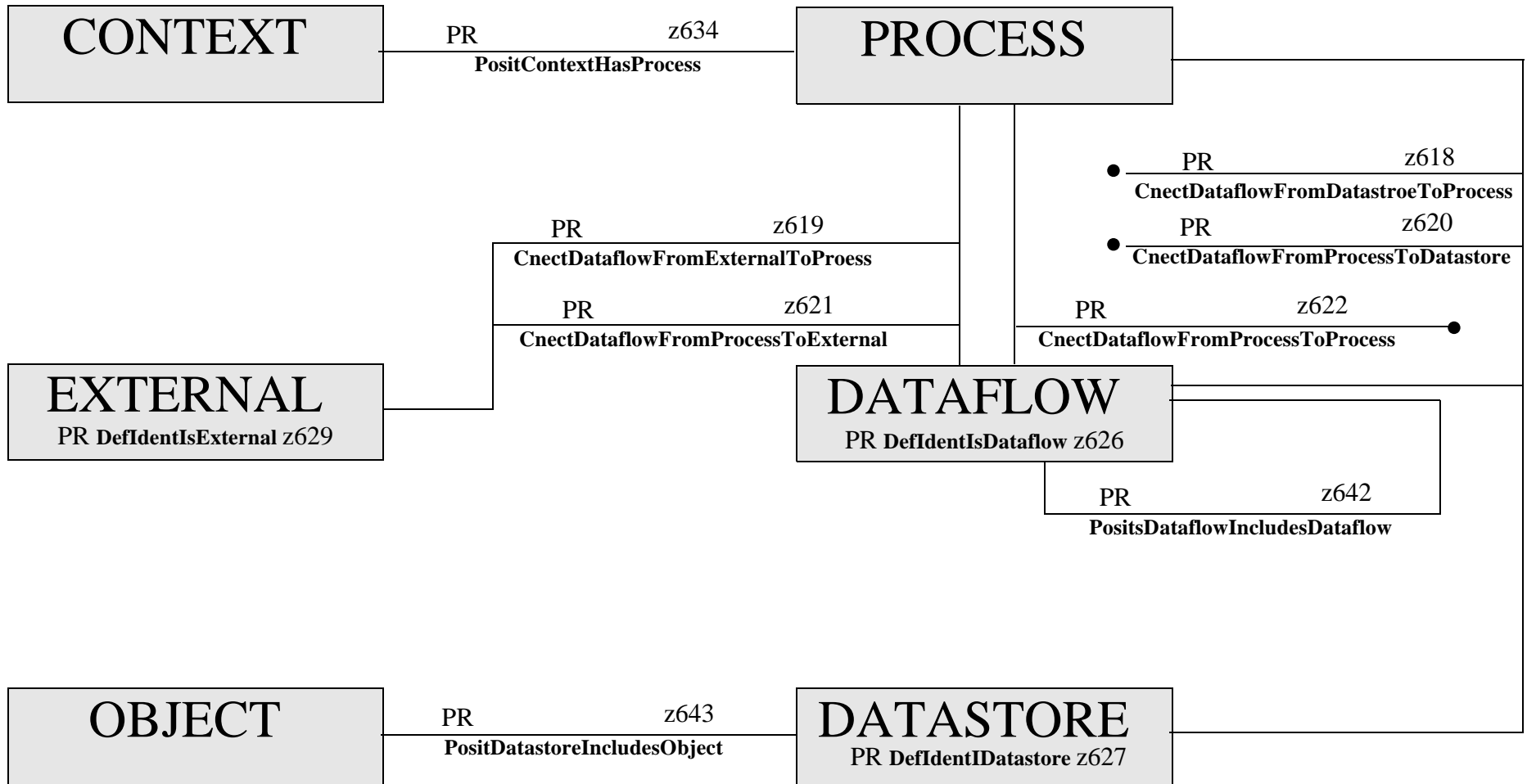

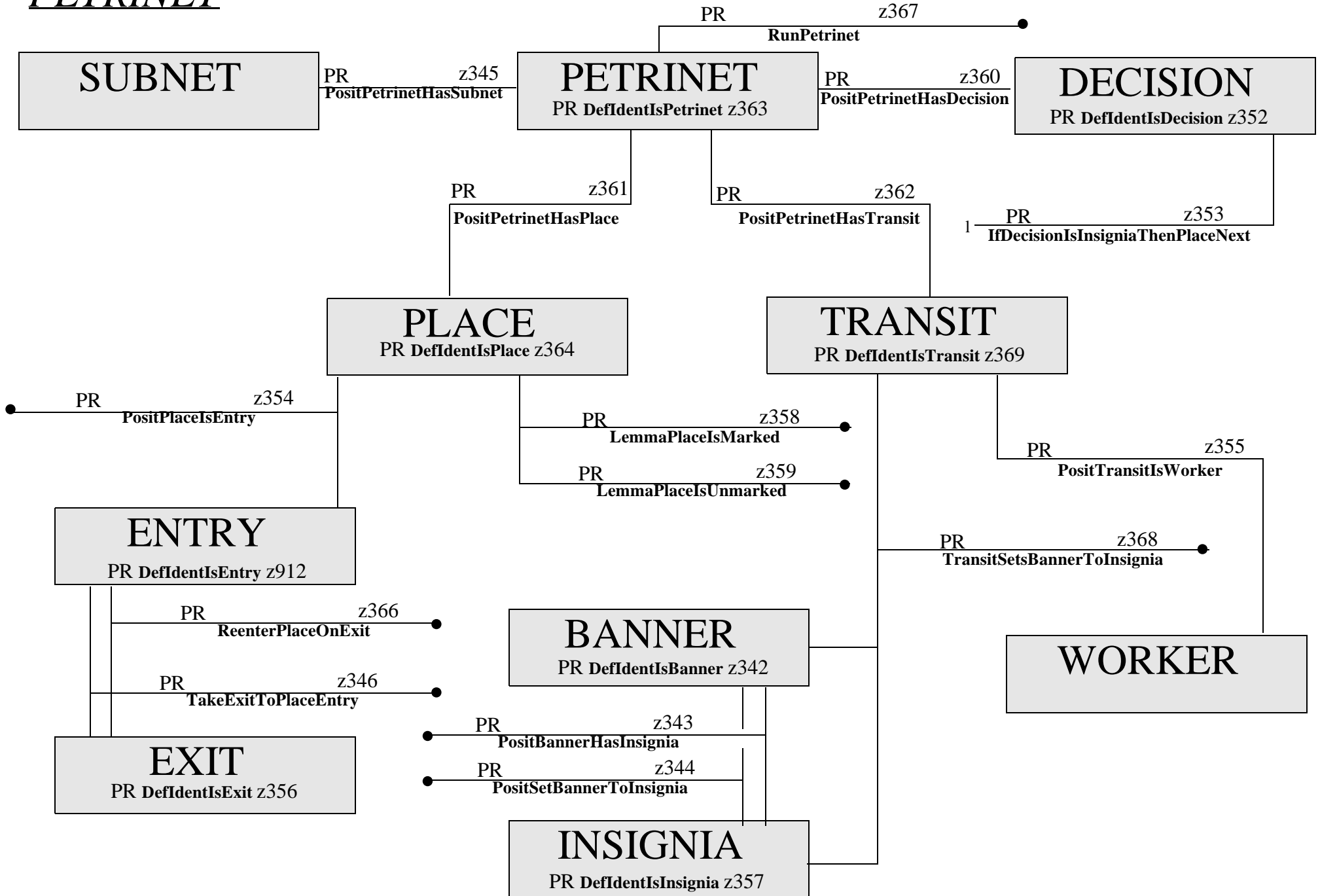



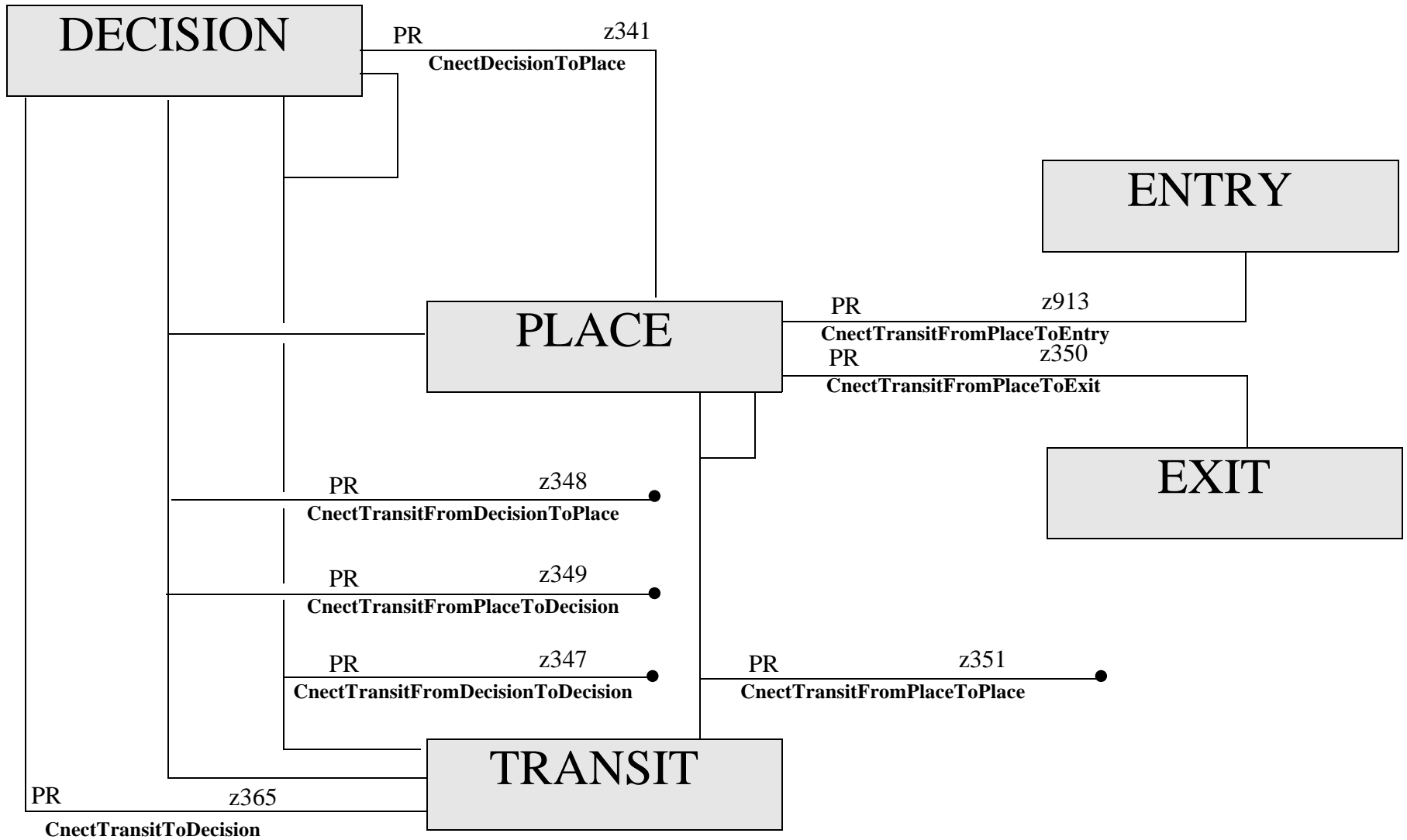

SITUATION

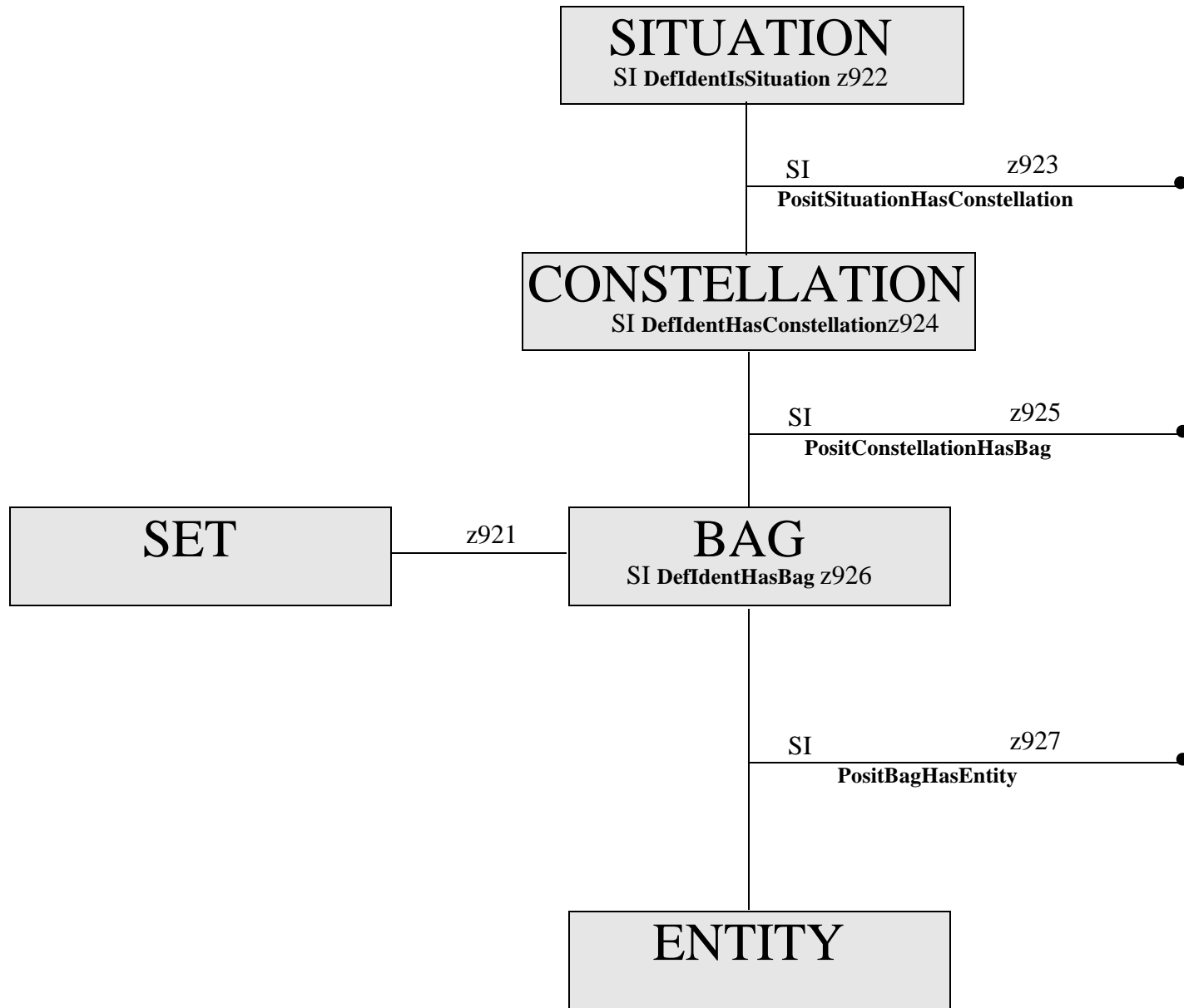

# *SITUATION*

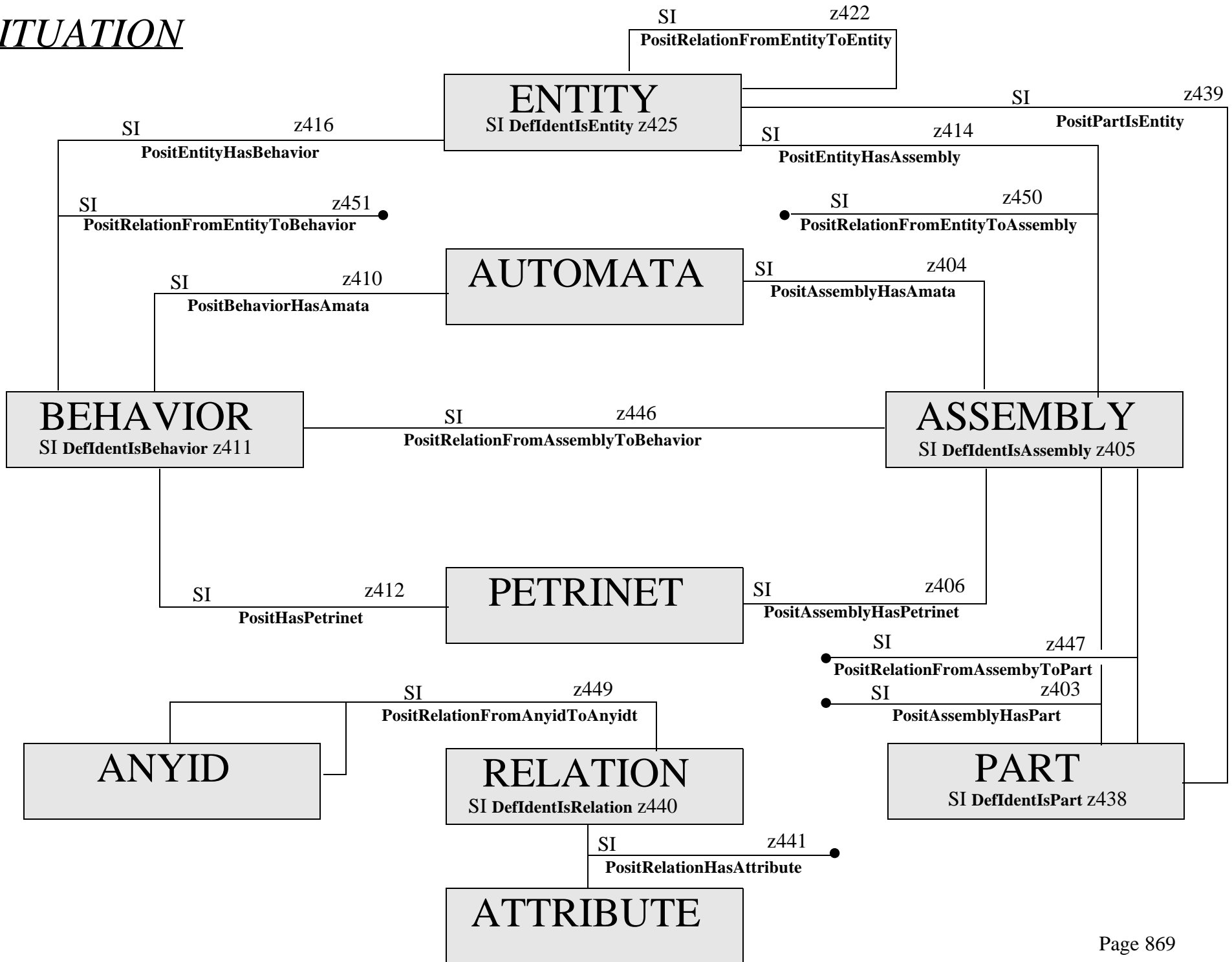

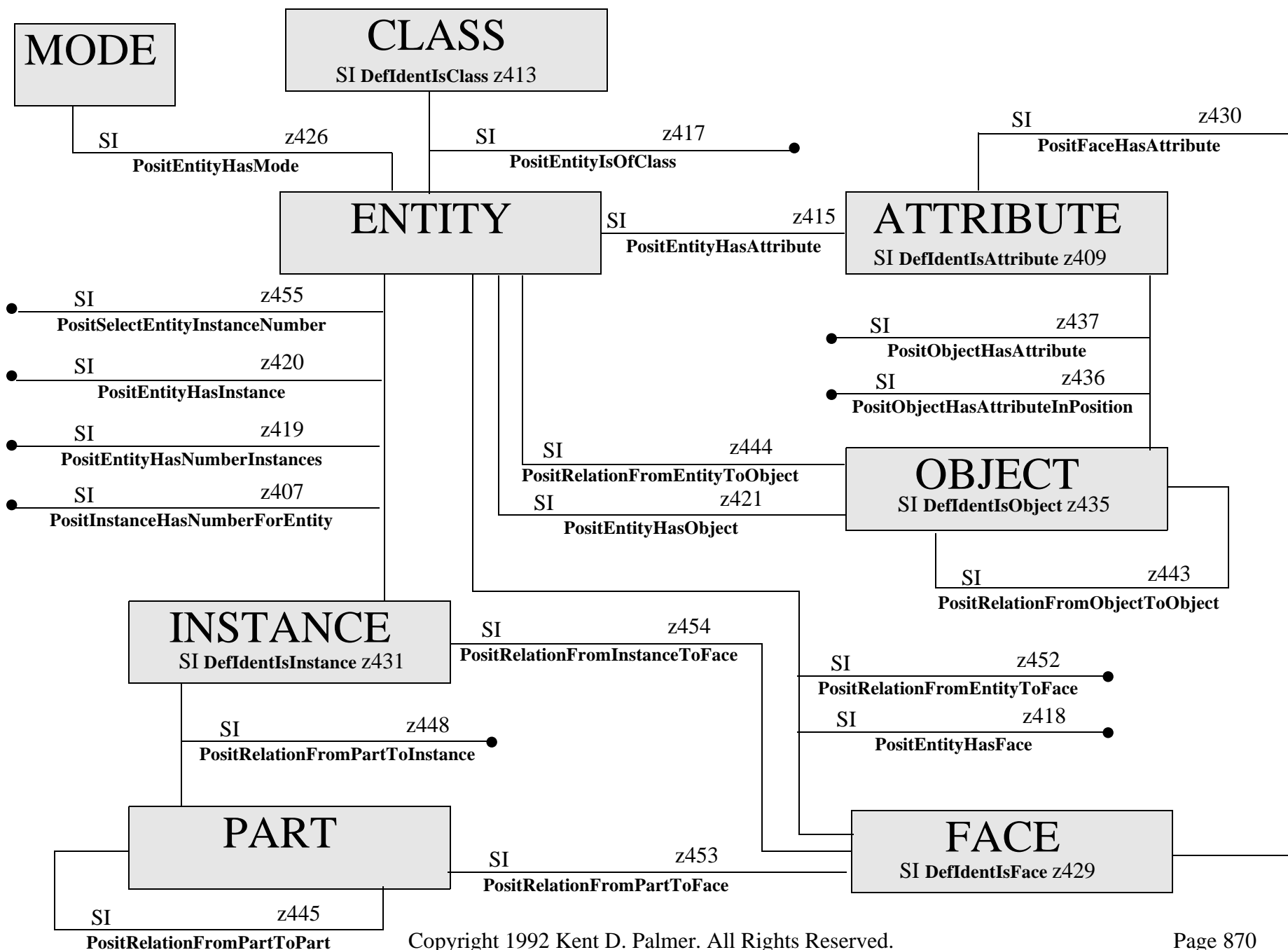

*SITUATION*

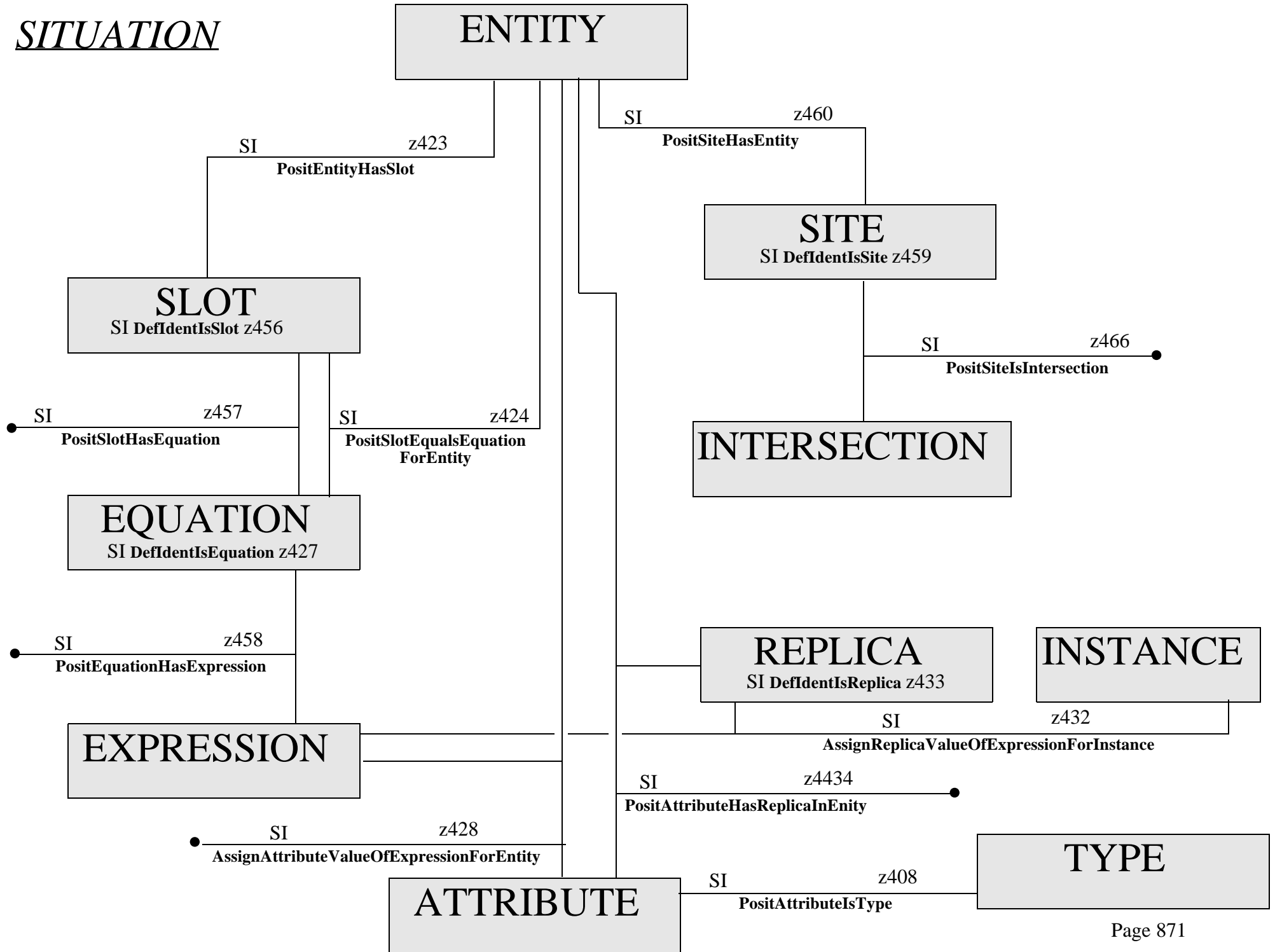

# *TEMPORALITY*

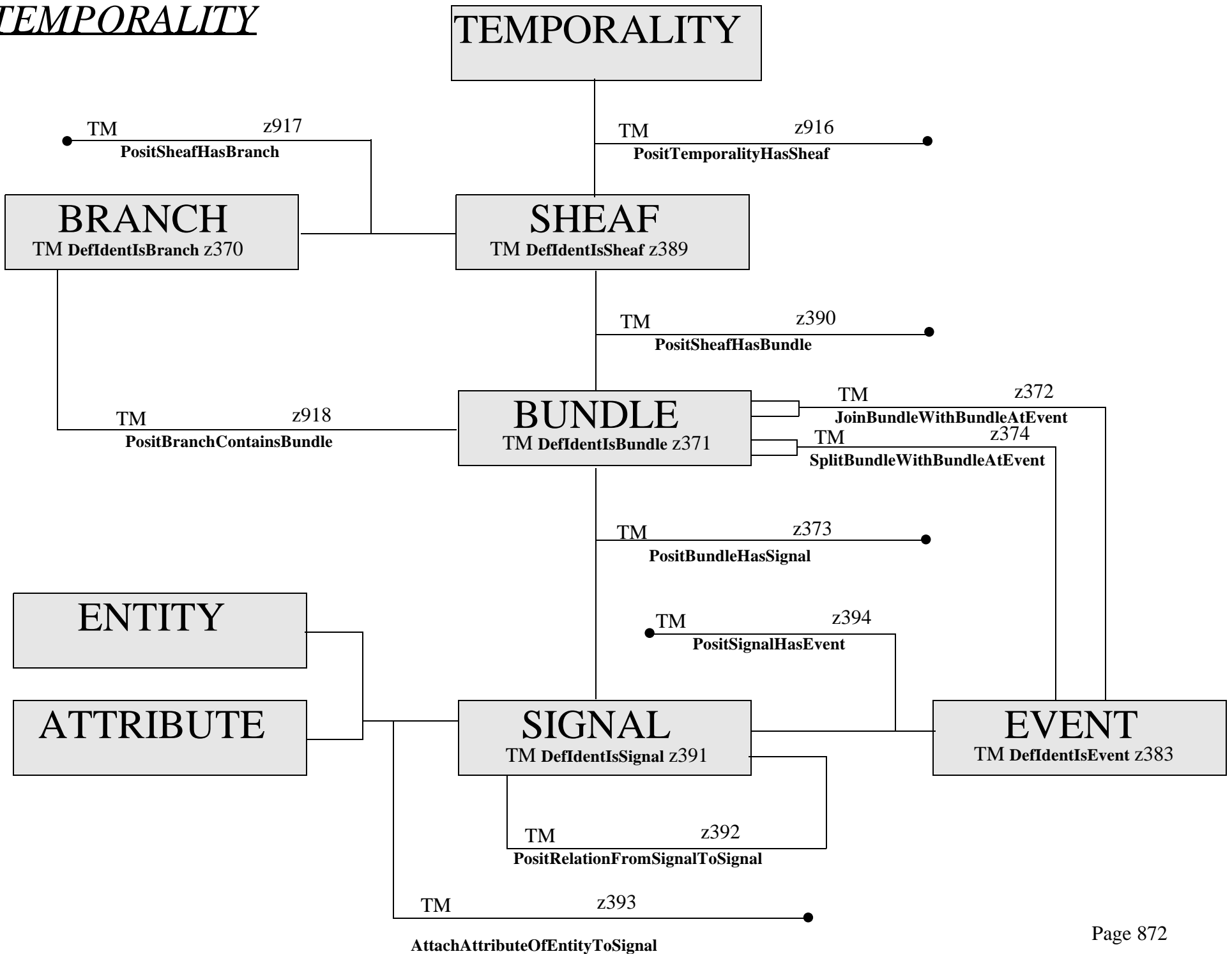

# TEMPORALITY

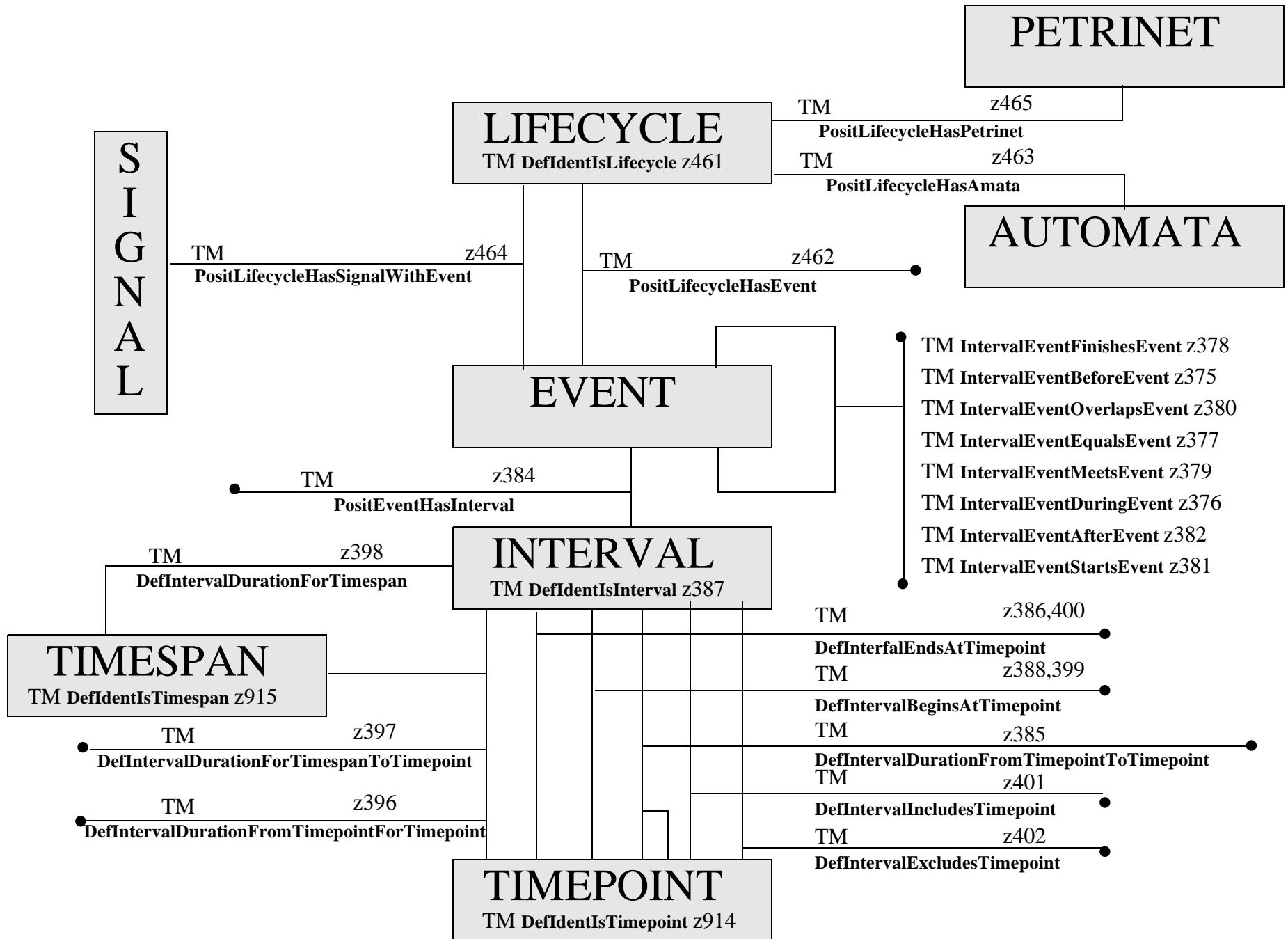

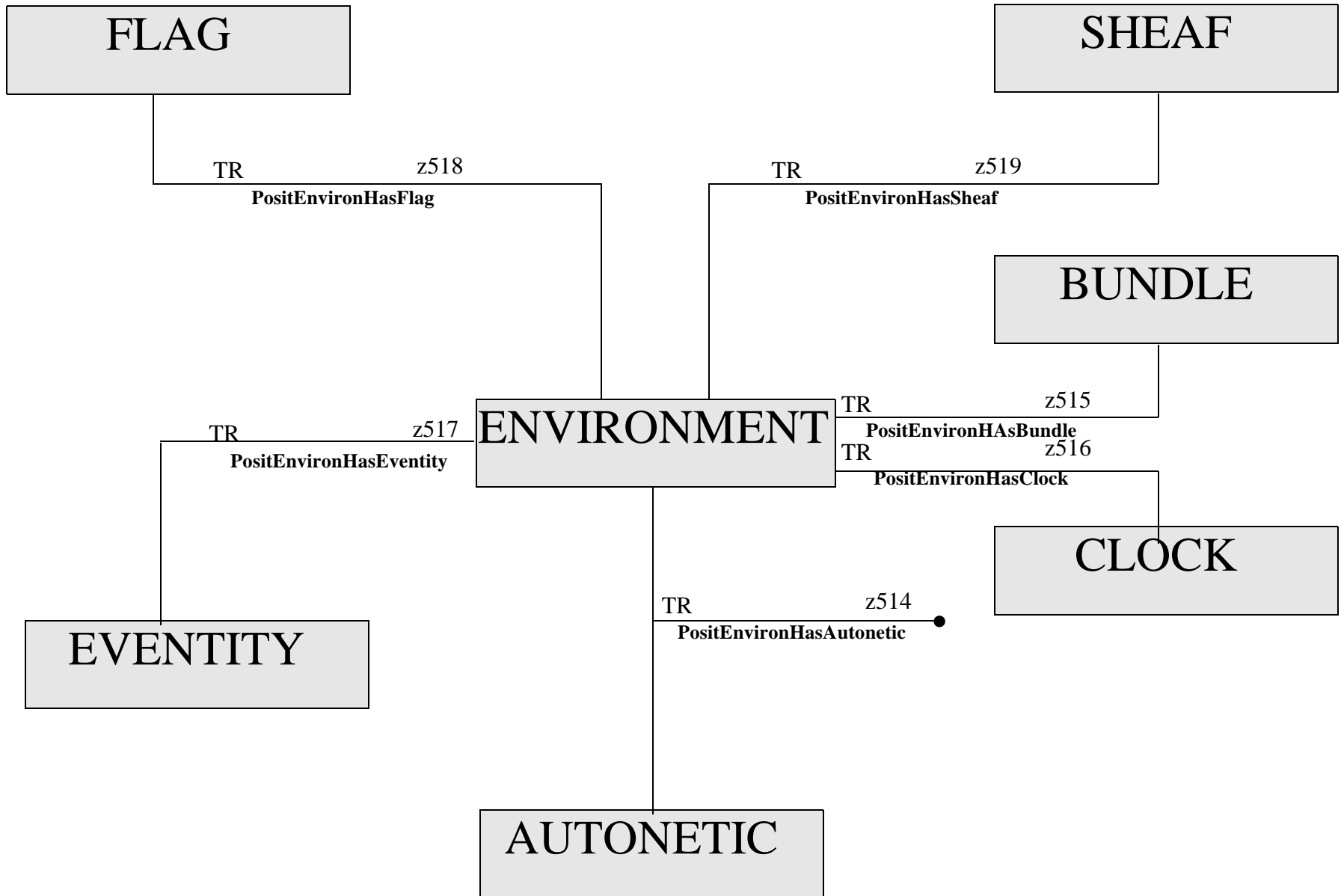



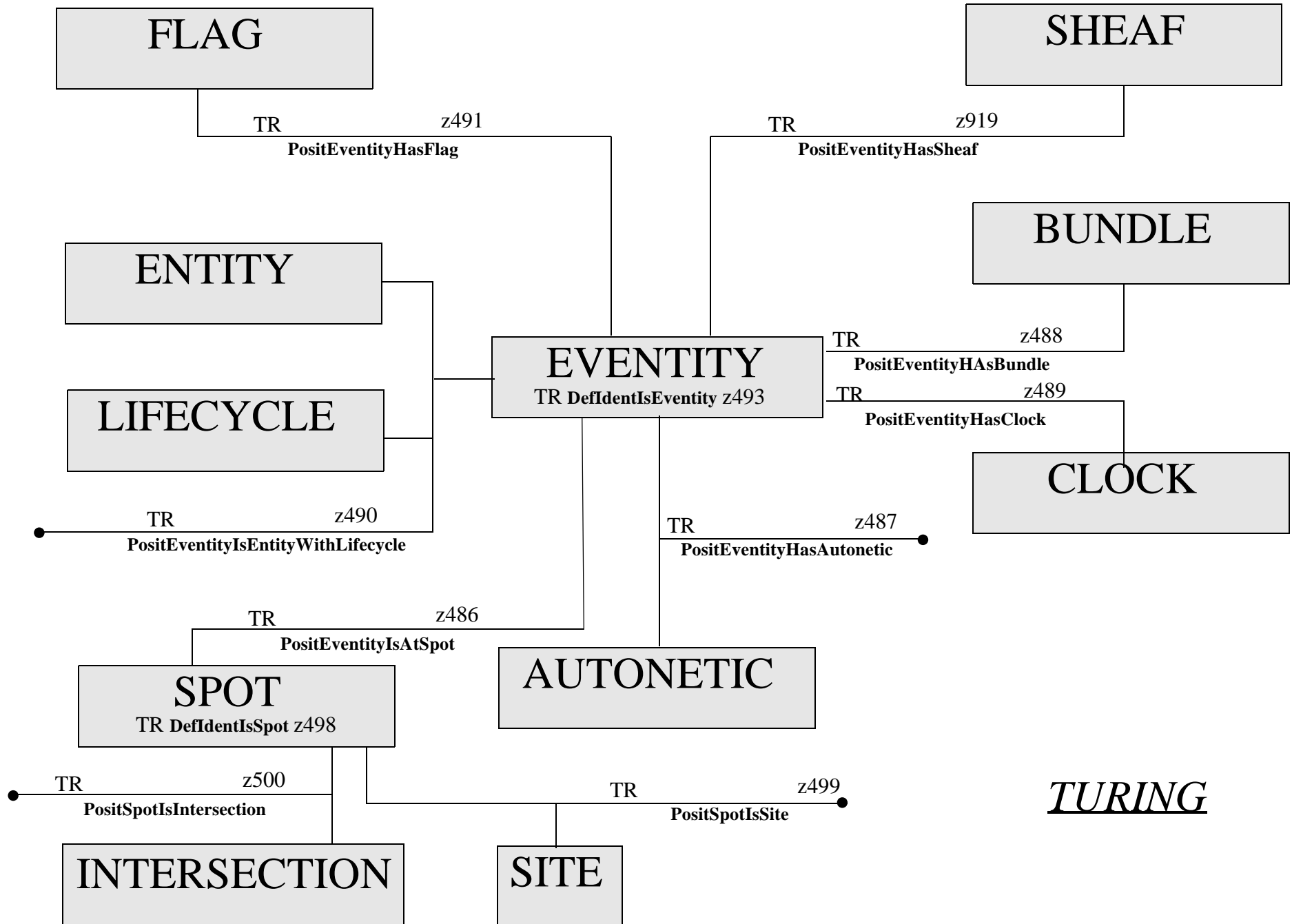

*TURING*

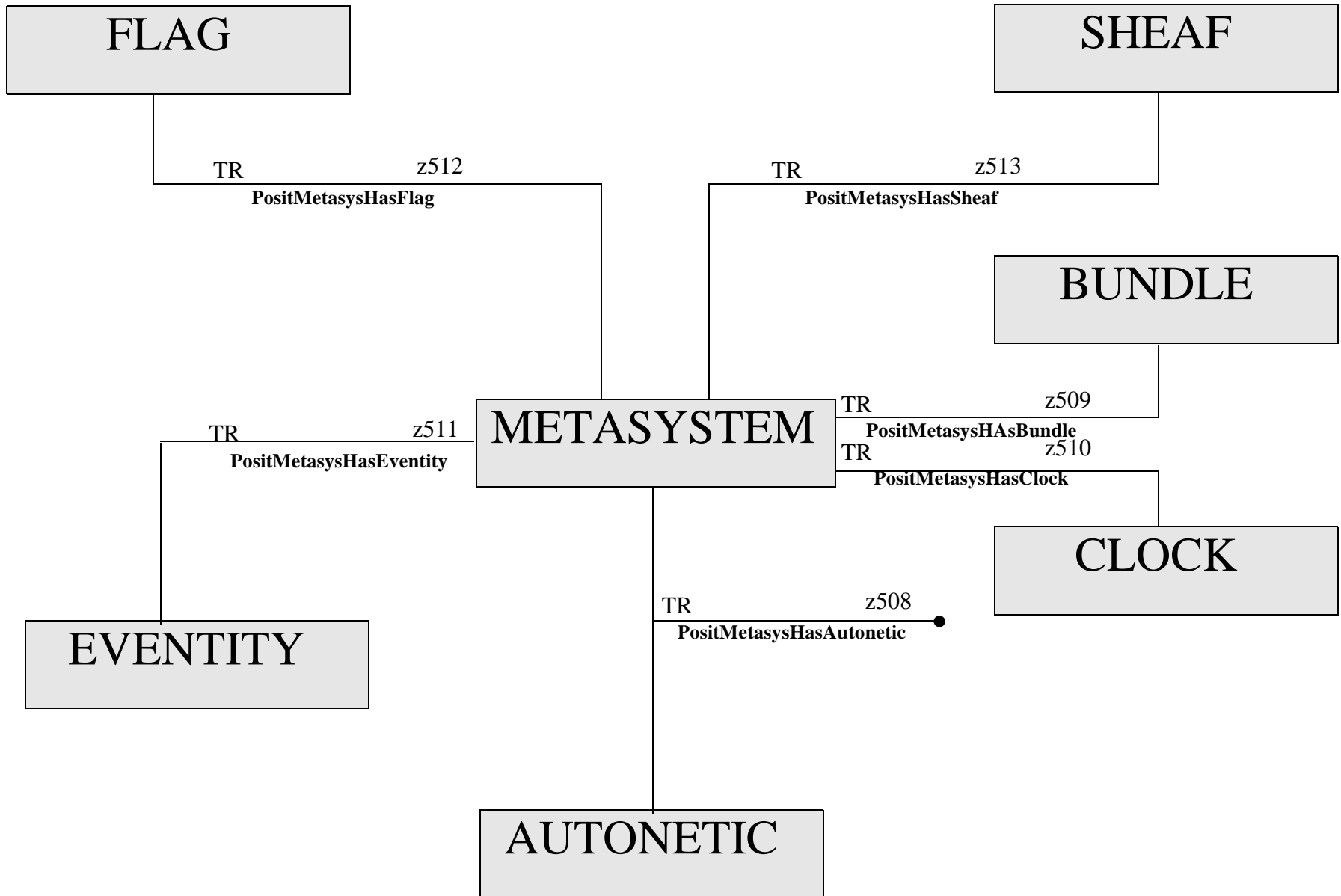

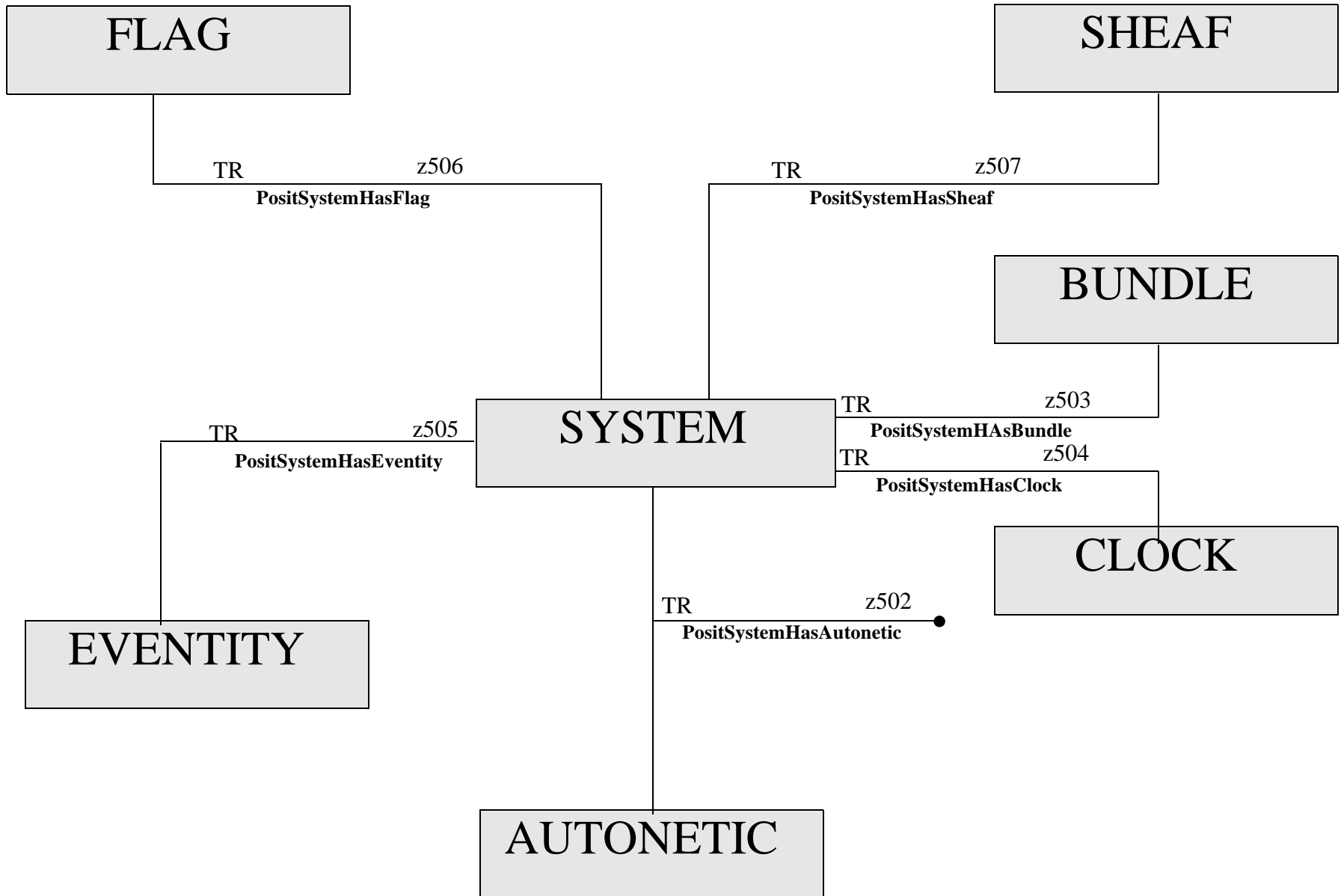

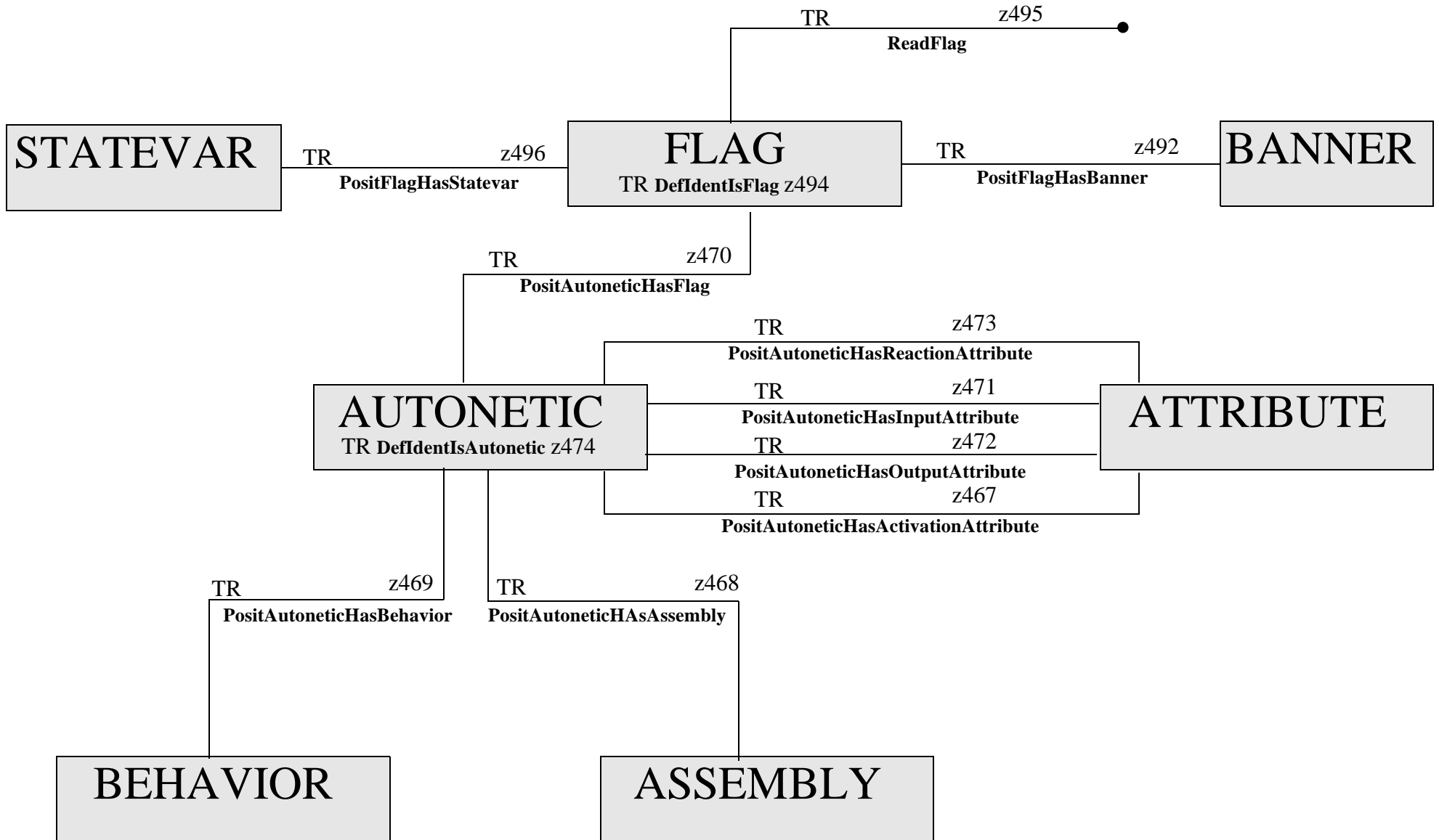

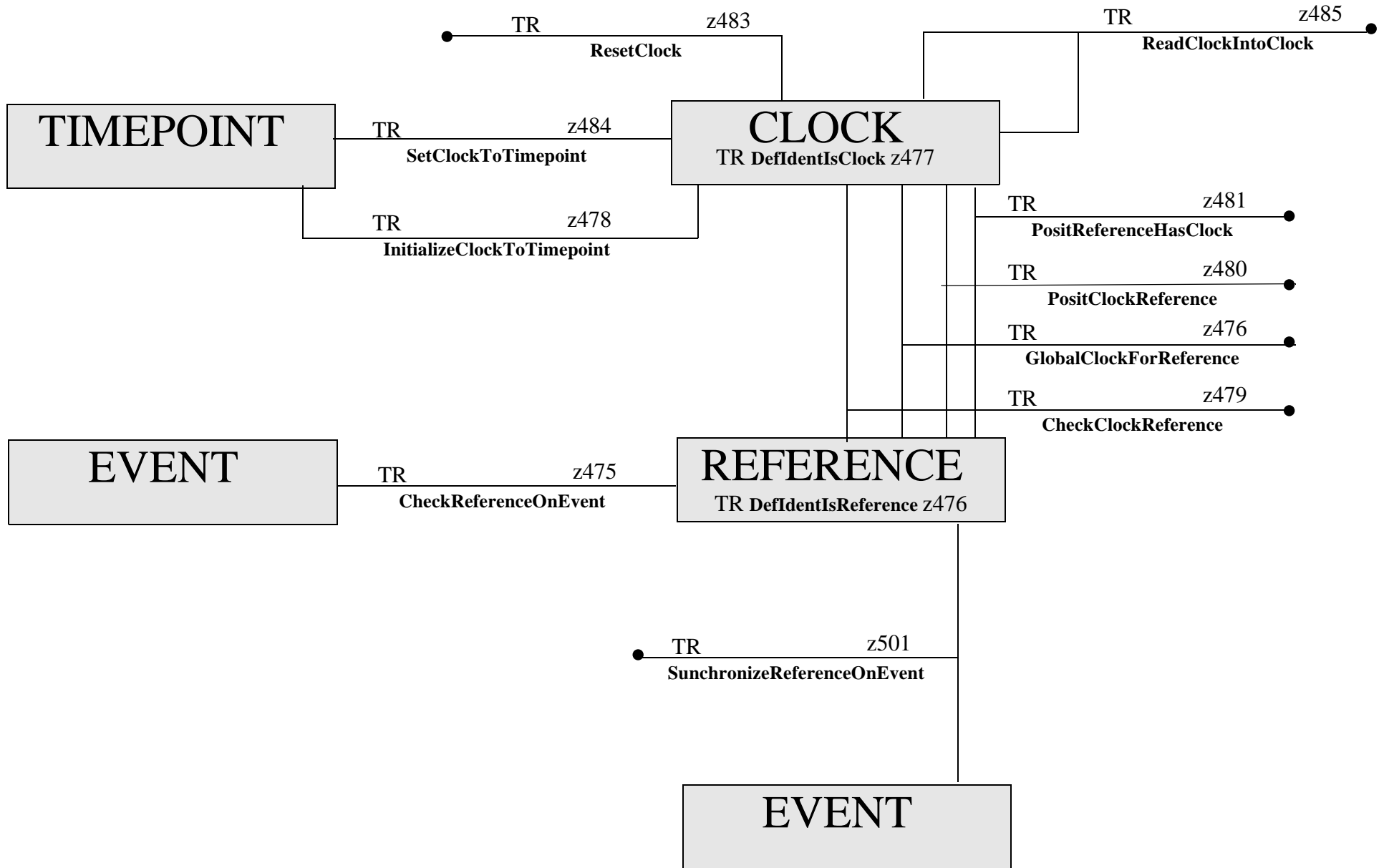

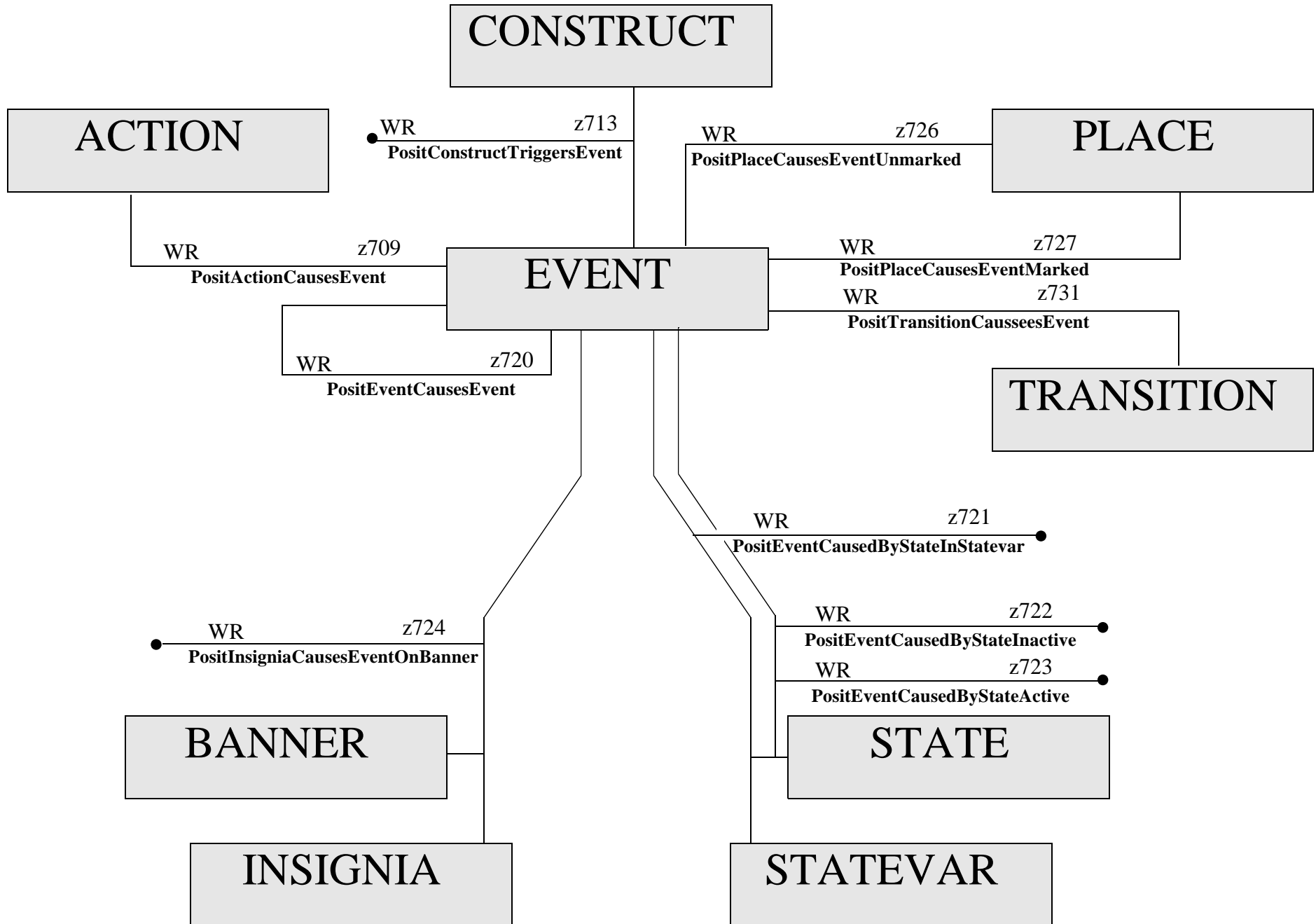

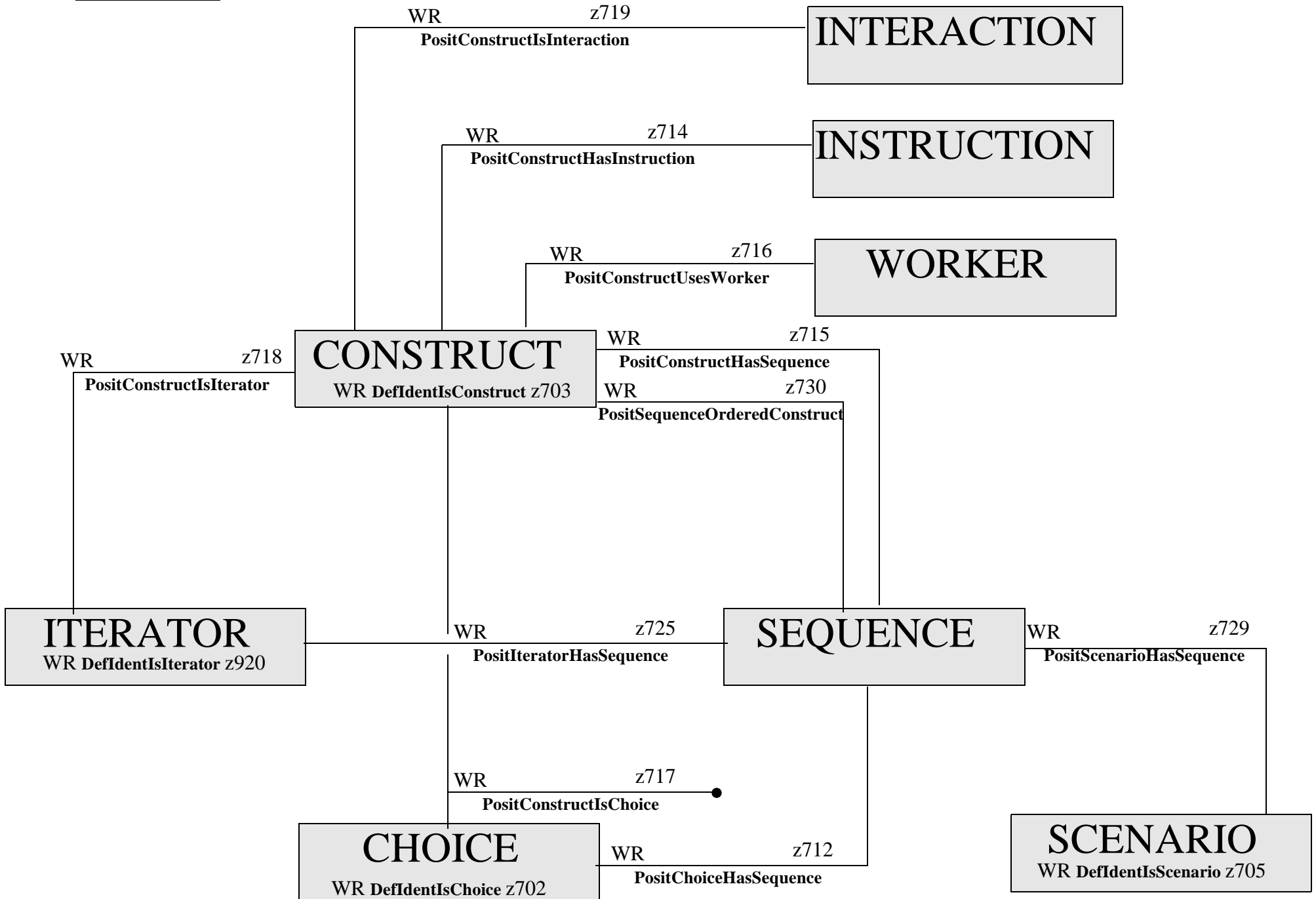

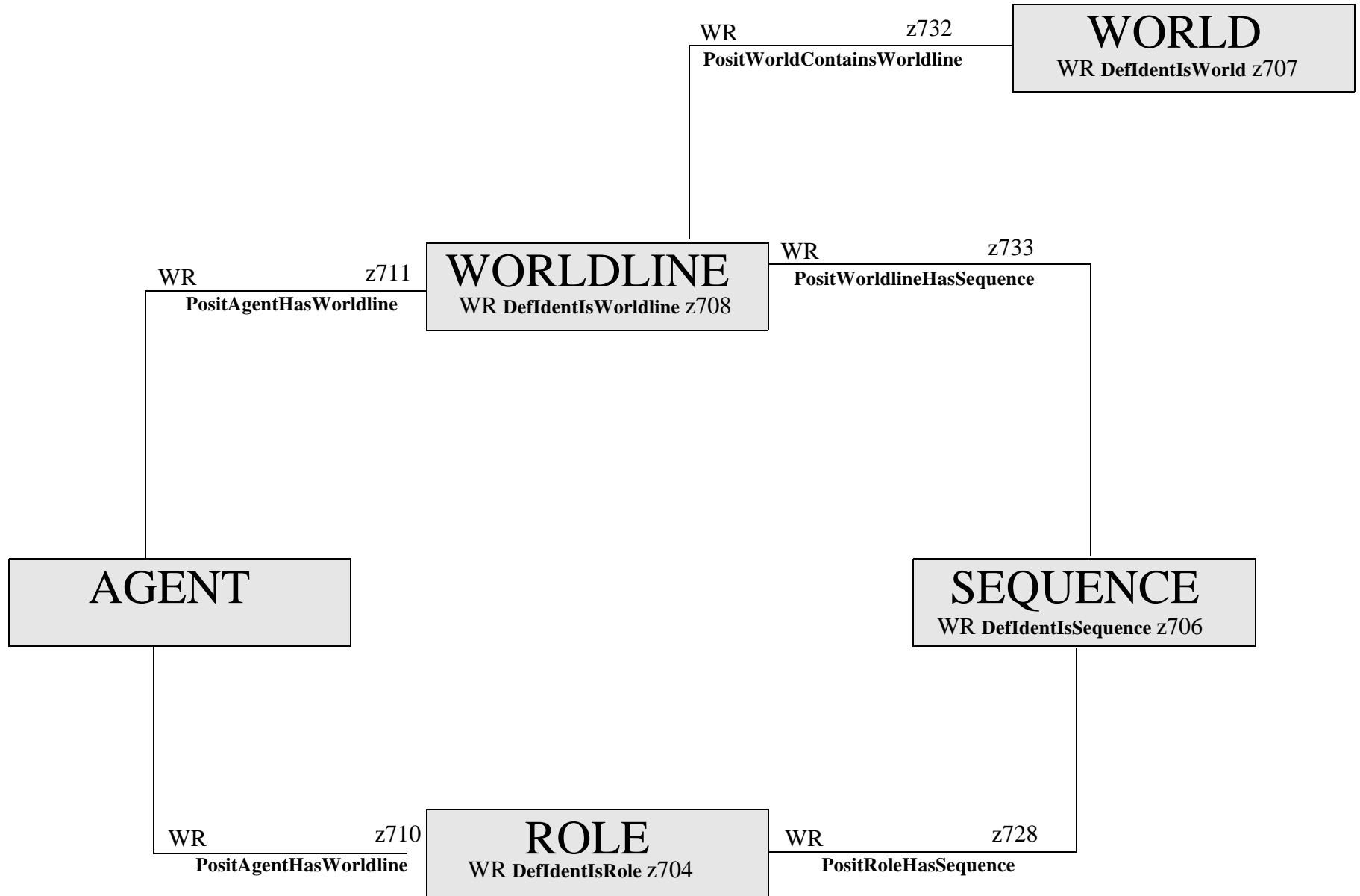



**Apeiron Press**

PO Box 4402  
Garden Grove,  
California 92842-4402

714-638-7376  
714-638-1210  
palmer@think.net  
palmer@netcom.com  
palmer@exo.com  
Dataline 714-638-0876

Copyright 1996 by Kent Duane Palmer

Draft #1 950710 Editorial Copy.  
Not for distribution.

All rights reserved. No part of this book may be reproduced in any form or by any means, electronic or mechanical, including photocopying, recording, or by any information storage and retrieval system, without permission in writing from the publisher.

This book was set using Framemaker document publishing software by the author.

Electronic Version in Adobe Acrobat PDF available at <http://server.snni.com:80/~palmer/homepage.html>

Library of Congress  
Cataloging in Publication Data

Palmer, Kent Duane

WILD SOFTWARE META-SYSTEMS

Bibliography  
Includes Index

1. Philosophy-- Ontology
2. Software Engineering
3. Software Design Methods

I. Title

[XXX000.X00 199x]

9x-xxxxx

ISBN 0-xxx-xxxxx-x

**Keywords:**

Software, Design Methods, Ontology,  
Integral Software Engineering  
Methodology, Systems Theory